

Hantek



Tablet1000 series

Tablet oscilloscope

User Manual

2022.05

Warranties and Declarations

Copyright

The copyright of this document belongs to Qingdao Hantek Electronics Co., LTD.

Statement

Qingdao Hantek Electronics Co., Ltd. reserves the right to amend this document without prior notice. Qingdao Hantek Electronics Co., Ltd. promises that the information provided is correct and reliable but does not guarantee that this document is free from errors. Before using this product, please make sure that the specifications of relevant technical documents are the latest effective version. If you use documents or products of Qingdao Hantek Electronics Co., LTD and need products, patents or works of third parties to cooperate with them, you shall be responsible for obtaining the consent and authorization of the third parties. The above consent and authorization shall not be the liability of Hantek.

Product certification

Hantek certified Tablet1000 series oscilloscope to meet China's national industry standards and has passed the CE certification.

Contact us

If you have any questions when using the products of Qingdao Hantek Electronics Co., LTD., you can obtain service and support through the following ways:

Email: service@hantek.com, support@hantek.com

Website: <http://www.hantek.com>

Contents

| | |
|---|-----|
| Contents | I |
| Figures..... | VII |
| Tables..... | IX |
| 1 Safety requirements..... | 1 |
| 1.1 Summary of general security issues..... | 1 |
| 1.2 Security terms and signs..... | 2 |
| 1.3 Measurement category..... | 2 |
| 1.4 Working conditions..... | 3 |
| 1.5 Maintenance and cleaning | 4 |
| 1.6 Environmental Considerations..... | 5 |
| 2 Product features..... | 6 |
| 3 Document overview | 8 |
| 4 Quick start..... | 11 |
| 4.1 General examination | 11 |
| 4.2 Appearance and dimension..... | 11 |
| 4.3 Preparation before use..... | 12 |
| 4.3.1 Connect the power supply | 12 |
| 4.3.2 Boot check..... | 13 |

| | | |
|-------|---|----|
| 4.3.3 | Set the system language | 13 |
| 4.3.4 | Functional check..... | 13 |
| 4.3.5 | Probe compensation..... | 13 |
| 4.4 | Product introduction | 15 |
| 4.4.1 | Front Panel | 15 |
| 4.4.2 | Rear Panel..... | 16 |
| 4.4.3 | Side panel..... | 17 |
| 4.4.4 | Main interface | 19 |
| 4.5 | Touch screen gesture | 20 |
| 4.5.1 | Touching..... | 20 |
| 4.5.2 | Kneading..... | 20 |
| 4.5.3 | Dragging | 21 |
| 4.6 | Setting parameters..... | 21 |
| 5 | Set the horizontal system..... | 24 |
| 5.1 | Adjust the horizontal displacement..... | 24 |
| 5.2 | Adjust the horizontal time base (time/grid)..... | 24 |
| 5.3 | Pan or zoom a single collection or stopped collection | 25 |
| 6 | Set the vertical system..... | 26 |
| 6.1 | Open or close the analog channel..... | 26 |

| | | |
|-------|---------------------------------------|----|
| 6.2 | Adjust the vertical sensitivity | 27 |
| 6.3 | Adjust the vertical offset | 27 |
| 6.4 | Channel coupling | 28 |
| 6.5 | 20M bandwidth limit | 28 |
| 6.6 | Waveform inversion | 29 |
| 6.7 | Probe | 29 |
| 6.8 | Amplitude unit | 29 |
| 7 | Mathematical operations | 31 |
| 7.1 | Algebraic operation | 31 |
| 7.2 | FFT operation | 32 |
| 8 | Reference channel | 35 |
| 9 | Trigger oscilloscope | 37 |
| 9.1 | Trigger level | 37 |
| 9.2 | Trigger data source | 37 |
| 9.3 | Trigger mode | 38 |
| 9.4 | Trigger hold-off | 38 |
| 9.5 | Trigger type | 39 |
| 9.5.1 | Edge-triggered | 39 |
| 9.5.2 | Pulse width trigger | 40 |

| | | |
|--------|----------------------------------|----|
| 9.5.3 | Video trigger | 42 |
| 9.5.4 | Slope trigger | 42 |
| 9.5.5 | Timeout trigger..... | 43 |
| 10 | Measure..... | 45 |
| 10.1 | Grid scale measurement | 45 |
| 10.2 | Measurement parameters | 45 |
| 10.2.1 | Time parameters..... | 46 |
| 10.2.2 | Count parameters | 47 |
| 10.2.3 | Delay and phase parameters | 48 |
| 10.2.4 | Voltage parameters | 49 |
| 10.3 | Cursor measurement | 50 |
| 10.3.1 | Vertical Cursor | 50 |
| 10.3.2 | Horizontal Cursor..... | 51 |
| 11 | Acquisition..... | 53 |
| 11.1 | Acquisition mode..... | 53 |
| 11.2 | Average times | 53 |
| 11.3 | Display mode | 54 |
| 11.4 | Storage depth | 55 |
| 11.5 | Interpolation methods..... | 56 |

| | | |
|------|---|----|
| 12 | Display | 58 |
| 12.1 | Type..... | 58 |
| 12.2 | Persistence | 58 |
| 12.3 | Grid..... | 59 |
| 12.4 | Grid brightness..... | 59 |
| 12.5 | Waveform brightness | 59 |
| 13 | Save..... | 60 |
| 14 | Calibration..... | 61 |
| 15 | Shortcuts..... | 62 |
| 15.1 | Auto setting | 62 |
| 15.2 | Default setting | 63 |
| 16 | Multimeter | 65 |
| 16.1 | Measurement..... | 66 |
| 17 | Signal source | 68 |
| 17.1 | Set the output waveform type and parameters | 68 |
| 17.2 | Set waveform modulation..... | 69 |
| 17.3 | Set burst | 69 |
| 17.4 | Edit arbitrary waveform | 70 |
| 17.5 | Output arbitrary waveform..... | 71 |

| | | |
|------|-----------------------------------|----|
| 18 | File browse..... | 73 |
| 19 | Settings..... | 75 |
| 20 | Gallery..... | 78 |
| 21 | Remote control..... | 79 |
| 22 | Fault handling | 81 |
| 23 | Appendix..... | 82 |
| 23.1 | Appendix A: Accessories..... | 82 |
| 23.2 | Appendix B: Warranty summary..... | 84 |

Figures

| | |
|---------------------------------------|----|
| Figure 4.1 Front view | 11 |
| Figure 4.2 Side view | 12 |
| Figure 4.3 Probe | 14 |
| Figure 4.4 Probe compensation..... | 14 |
| Figure 4.5 Adjust the probe..... | 15 |
| Figure 4.6 Front panel | 15 |
| Figure 4.7 Rear view | 16 |
| Figure 4.8 Right panel | 17 |
| Figure 4.9 Left panel..... | 17 |
| Figure 4.10 Upper panel | 18 |
| Figure 4.11 Main interface | 19 |
| Figure 4.12 Touching gesture | 20 |
| Figure 4.13 Kneading gesture | 21 |
| Figure 4.14 Dragging gesture | 21 |
| Figure 4.15 Character keyboard..... | 22 |
| Figure 4.16 Numeric keypad..... | 23 |
| Figure 6.1 Channel vertical menu..... | 26 |
| Figure 6.2 Waveform inversion..... | 29 |
| Figure 7.1 Math operation menu..... | 31 |
| Figure 7.2 Addition operation..... | 32 |
| Figure 7.3 FFT operation | 33 |

| | |
|--|----|
| Figure 8.1 Reference waveform | 36 |
| Figure 9.1 Trigger hold-off | 39 |
| Figure 9.2 Edge trigger menu | 40 |
| Figure 9.3 Pulse width trigger menu | 41 |
| Figure 9.4 Video trigger menu | 42 |
| Figure 9.5 Slope trigger menu | 43 |
| Figure 9.6 Timeout trigger menu..... | 44 |
| Figure 10.1 Measurement parameters | 45 |
| Figure 10.2 Vertical cursor..... | 50 |
| Figure 10.3 Horizontal cursor | 51 |
| Figure 11.1 Phase difference schematic diagram..... | 54 |
| Figure 11.2 Scroll mode..... | 55 |
| Figure 11.3 Schematic diagram of storage depth | 56 |
| Figure 14.1 Calibration menu | 61 |
| Figure 16.1 Multimeter..... | 65 |
| Figure 17.1 Signal source..... | 68 |
| Figure 17.2 Arbitrary wave editor..... | 70 |
| Figure 18.1 File browse | 73 |
| Figure 20.1 Gallery | 78 |

Tables

| | |
|--|----|
| Table 3.1 Model | 10 |
| Table 15.1 Automatic setting..... | 63 |
| Table 15.2 Automatic setting of sine waves | 63 |
| Table 15.3 Default setting | 64 |
| Table 19.1 Settings | 75 |

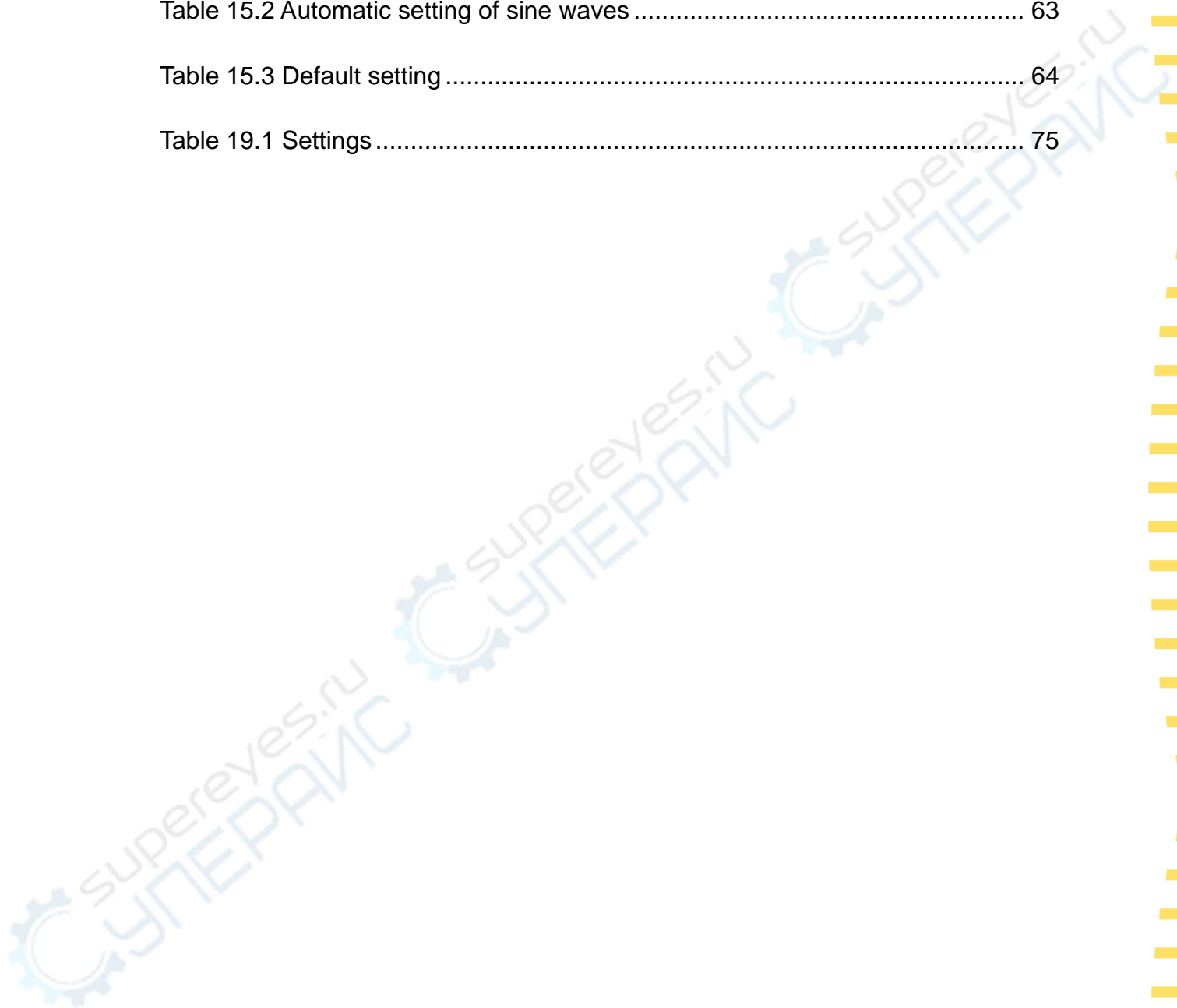

1 Safety requirements

1.1 Summary of general security issues

Read the following safety precautions carefully to avoid injury and to prevent damage to this product or any product connected. To avoid possible dangers, please use this product in accordance with the regulations.

- **Only professionally authorized personnel can perform repairs.**

- **Use the right power cable.**

Use the power cable approved by the country in which the product is used only.

- **Connect and disconnect correctly.**

Before connecting the probe to the circuit being measured, please connect the probe to the oscilloscope first. Before disconnecting the probe from the oscilloscope, please disconnect the probe and the circuit under test first.

- **Ground the product.**

To avoid electric shocks, the product is grounded through a grounding conductor of the power cable. The grounding conductor must be connected to the ground before connecting the input or output terminals of the product. Ensure that the product is properly grounded.

- **Connect the probe properly.**

The ground wire of the probe is the same as the ground potential. Do not connect the ground wire to high voltage.

- **View all terminal rating values.**

To avoid fire or excessive current, please check all rating values and signs on the product. Please consult the product manual for details of the rating values before connecting the product.

- **Do not operate with the cover open.**

Do not run the product with the cover or panel open.

- **Avoid circuit exposure.**

Do not touch exposed connectors and components after power is switched on.

- **Do not operate if the product is suspected to be faulty.**

If you suspect that the product has been damaged, please ask qualified maintenance personnel to check it.

- Maintain proper ventilation.
- Do not operate in a humid environment.
- Do not operate in inflammable or explosive environment.
- Please keep the product surface clean and dry.

**Warning:**

Equipment that meets Class A requirements may not provide adequate protection for broadcast services in residential environments.

1.2 Security terms and signs

Security terms in this manual:

**Warning:**

Indicates that the operation may not cause immediate damage to you.

**Note:**

Indicates that the operation may cause damage to the product or other property.

Safety terms on products:

Warning:

Indicates a potential hazard may be caused to you if you do not perform this operation.

Safety signs on the product:



警告

1.3 Measurement category

Measurement category

This instrument can be used for measurement under class I.



Warning:

This instrument is only allowed to be used in the specified measurement class.

Measurement class definition

- **Class I refers to measurements taken on a circuit not directly connected to the main power supply.** For example, measurements made on circuits that are not exported from a main power supply, especially from a protected (internal) main power supply. In the latter case, the instantaneous stress will change. Therefore, the user should understand the instantaneous capacity of the instrument.
- **Class II refers to measurements taken on a circuit directly connected to low-voltage instruments.** For example, measurements made on household appliances, portable tools, and similar equipment.
- **Class III refers to measurements taken on construction equipment.** For example, measurements made on switchboards, circuit breakers, circuits (including cables, busbars, junction boxes, switches, sockets) in fixed equipment, as well as equipment for industrial use and certain other equipment (for example, fixed motors permanently connected to fixed instruments).
- **Class IV refers to measurements taken at the source of low-voltage equipment.** For example, measurements made on electricity meters, primary overcurrent protection equipment, and pulse control units.

1.4 Working conditions

The temperature

Operating temperature: 0°C -50°C

Storage temperature: -20°C -70°C

Humidity

≤+104°F (≤+40°C): Rh≤90%

106°F to 122°F (+41°C to 50°C): Humidity≤60%



Warning:

To avoid short circuit or electric shock, do not operate the device in a damp environment.

The altitude

In and out of operation: 3,000m (10,000 ft).

Random vibration: 0.31g RMS at 50Hz to 500Hz, 10 minutes in each axial direction.

No operation: 2.46g RMS from 5Hz to 500Hz, 10 minutes in each axial direction.

Installation (Overvoltage) Class This product is powered by a mains supply conforming to **Installation (overvoltage) Class II**.



Warning:

Ensure that no overvoltage (e.g. from lightning) reaches the product. Otherwise, the operator may be in danger of receiving electric shock.

Installation (overvoltage) class definition

Installation (overvoltage) Class I refers to the signal level applicable to the device measurement terminals connected to the source circuit where measures have been taken to limit the instantaneous voltage to the corresponding low level.

Installed (overvoltage) Class II refers to the local distribution level for equipment connected to a mains (AC supply).

The degree of pollution

2 class

Definition of pollution level

- **Pollution degree 1: no pollution, or only dry non-conductive pollution.** This pollution level has no impact. For example: clean room or air-conditioned office environment.
- **Pollution level 2: generally only dry non-conductive pollution occurs.** Transient conduction due to condensation may sometimes occur. For example: general indoor environment.
- **Pollution level 3: conductive pollution occurs, or dry non-conductive pollution becomes conductive by condensation.** For example, an outdoor environment with a canopy.
- **Pollution level 4: Permanent conductive pollution through conductive dust, rain, or snow.** For example: outdoor places.

Security level

Class 1 - Grounded products

1.5 **Maintenance and cleaning**

Maintenance:

Do not expose the LCD to direct sunlight for a long time when storing or placing the oscilloscope.

Cleaning:

If the oscilloscope and probe are inspected frequently as required by operating

conditions, clean the outer surface of the instrument by following the following steps:

- 1) Use a lint - free cloth to remove the dust outside the oscilloscope and probe. Please be careful to avoid scratching the smooth display filter material.
- 2) Clean the oscilloscope with a soft cloth soaked in water. For a more thorough cleaning, use a aqueous solution of 75% isopropyl alcohol.



Note:

In order to avoid damaging the surface of oscilloscope or probe, do not use any corrosive reagent or chemical cleaning reagent.



Warning:

Before powering on the device again, ensure that the device is dry enough to avoid electrical short circuit or personal injury caused by moisture.

1.6 Environmental Considerations

The following symbols indicate that the product complies with the requirements of WEEE Directive 2002/96/EC.



Equipment recovery:

Producing the device requires the extraction and use of natural resources. Some substances contained in the equipment may be harmful to the environment or human health if the product is not disposed of properly. In order to avoid the release of harmful substances into the environment and reduce the use of natural resources, it is recommended that appropriate methods be used to recycle this product to ensure that most of the materials can be correctly reused.

2 Product features

Product features

- 7-inch industrial TFT-LCD, 800*480 multi-point full touch capacitive touch screen, completely get rid of mechanical keys, better operation experience.
- Number of channels: 4-channel flat panel oscilloscope: 4 channels +1 AFG channel (1KHz channel without signal source function). 2-channel flat panel oscilloscope: 2 channels +1 AFG channel (1KHz channel without signal source function).
- Analog channel bandwidth: 250MHz Max.
- Maximum sampling rate: 4-channel flat panel oscilloscope: 1GSa/s single channel, 500MSa/s double channel, 250MSa/s three or four channels. 2-channel flat panel oscilloscope: 250MSa/s double channel, 125MSa/s single channel.
- Maximum storage depth: 4-channel flat panel oscilloscope: 8Mpts (single channel), 4Mpts (double channel), 2Mpts (three or four channels). 2-channel flat panel oscilloscope: 8Mpts (single channel), 4Mpts (double channel).
- Vertical sensitivity: 4-channel flat panel oscilloscope: 2mV/div ~ 10V /div.
2-channel flat plate oscilloscope: 10mV/div ~ 10V /div.
- Product classification: only with oscilloscope function of 7 inch flat plate oscilloscope, with oscilloscope + multimeter function of 7 inch flat plate oscilloscope, with oscilloscope + multimeter + signal source function of 7 inch flat plate oscilloscope.
- Basic trigger functions: edge, pulse width, video, slope, timeout.
- Up to 42 waveform parameters are automatically measured.
- Various mathematical operations: addition, subtraction, multiplication, division, FFT.
- Standard port: USB port.
- Standard 9V2A/5V3A/12v1.5A charger, data line interface input, and mobile phone can share a set of charging equipment.
- 4 channel flat panel oscilloscope: built-in 10000mAh removable lithium battery; 2 channel flat panel oscilloscope: built-in 5000mAh removable lithium battery.
- With the design of supporting foot, it can be used and put to save working space.
- Quick storage function, one key to save waveform to U disk or internal storage, convenient and fast.
- New man-machine touch interactive experience, simple and clear UI, without complex operation, everyone can easily use the professional instrument.
- The 7 "large screen display is the same as that of the desktop, which can be used as the desktop or handheld.
- Large screen, small volume, the net weight of the whole machine is less than 1Kg, and mobile phone share charger, convenient to carry on business trips.

TO1000 series of a new generation of handheld flat oscilloscopes, using 7-inch industrial specification TFT-LCD800*480 resolution LCD screen, support multi-point capacitive touch operation;With oscilloscope, signal source, multimeter three functions;Oscilloscope has 4 analog channels or 2 analog channels;Its own signal source support 25MHz standard waveform output, built-in a variety of arbitrary wave;The

multimeter has its own data recording function, which can monitor and record voltage, current, resistance and other data changes for a long time and generate trend charts; Standard 9V2A/5V3A/ 12v1.5A charger, USB interface input, can share a set of charging equipment with mobile phone; Powered by 4 or 2 18650 lithium batteries; Adopt the design of supporting foot, as you use as you put.



3 Document overview

This document describes how to quickly understand the front and back panels, user interfaces, and basic operation methods of the Tablet1000 series digital oscilloscopes.



Tip:

The latest version of this manual can be downloaded at (<http://www.hantek.com>).

Document number:

202205

Software version:

Software upgrade may change or increase product functionalities, please pay attention to Hantek website for the latest version.

Document format conventions:

1 Virtual keys and main interface icons

Use [name] to represent virtual keys and main interface icons. For example, [HOME] is

for  [HOME], [OSC] is for .

2 Menu

Use "menu text (bold) + color" to represent a label or a menu option. For example, **Basic Settings** means to click the "Basic Settings" option on the current operation interface to enter the function configuration menu of "Basic Settings".

3 Operation steps

Use ">" to represent the next step. For example, **Utility**> **Acquire** means click **Utility** label before clicking **Acquire** menu.

Document content conventions:

Tablet1000 series tablet oscilloscope consists of the following models. Unless otherwise specified, this manual uses TO1254D as an example to describe the Tablet1000 series and basic operations.

| Model | Channel | Bandwidth | Sampling rate | Signal source | Multimeter |
|---------|---------|-----------|---------------|---------------|------------|
| TO1112 | 2 | 110MHz | 250MSa/S | - | - |
| TO1112C | 2 | 110MHz | 250MSa/S | - | Yes |
| TO1112D | 2 | 110MHz | 250MSa/S | 25MHz | Yes |

| Model | Channel | Bandwidth | Sampling rate | Signal source | Multimeter |
|------------|---------|-----------|---------------|---------------|------------|
| TO1152 | 2 | 150MHz | 1GSa/S | - | - |
| TO1202 | 2 | 200MHz | 1GSa/S | - | - |
| TO1252 | 2 | 250MHz | 1GSa/S | - | - |
| TO1152C | 2 | 150MHz | 1GSa/S | - | Yes |
| TO1202C | 2 | 200MHz | 1GSa/S | - | Yes |
| TO1252C | 2 | 250MHz | 1GSa/S | - | Yes |
| TO1152D | 2 | 150MHz | 1GSa/S | 25MHz | Yes |
| TO1202D | 2 | 200MHz | 1GSa/S | 25MHz | Yes |
| TO1252D | 2 | 250MHz | 1GSa/S | 25MHz | Yes |
| TO1154 | 4 | 150MHz | 1GSa/S | - | - |
| TO1204 | 4 | 200MHz | 1GSa/S | - | - |
| TO1254 | 4 | 250MHz | 1GSa/S | - | - |
| TO1154C | 4 | 150MHz | 1GSa/S | - | Yes |
| TO1204C | 4 | 200MHz | 1GSa/S | - | Yes |
| TO1254C | 4 | 250MHz | 1GSa/S | - | Yes |
| TO1154D | 4 | 150MHz | 1GSa/S | 25MHz | Yes |
| TO1204D | 4 | 200MHz | 1GSa/S | 25MHz | Yes |
| TO1254D | 4 | 250MHz | 1GSa/S | 25MHz | Yes |
| TO1154AUTO | 4 | 150MHz | 1GSa/S | 25MHz | Yes |
| TO1204AUTO | 4 | 200MHz | 1GSa/S | 25MHz | Yes |

| Model | Channel | Bandwidth | Sampling rate | Signal source | Multimeter |
|------------|---------|-----------|---------------|---------------|------------|
| TO1254AUTO | 4 | 250MHz | 1GSa/S | 25MHz | Yes |

Table 3.1 Model

4 Quick start

4.1 General examination

Check the shipping package

After receiving the oscilloscope, please follow the following steps to check the instrument: Check whether there is any damage caused by transportation: If the packaging cartons or protective foam pads are seriously damaged, please keep them until the whole machine and accessories pass the electrical and mechanical testing.

Check the accessories

The details of the accessories are provided in Appendix A: Accessories at the end of the user manual. If you find any accessory missing or damaged, please contact the dealer responsible for this business.

Check the machine

If you find the instrument is damaged, not working properly, or unable to pass the performance test, please contact the dealer responsible for this business.

4.2 Appearance and dimension

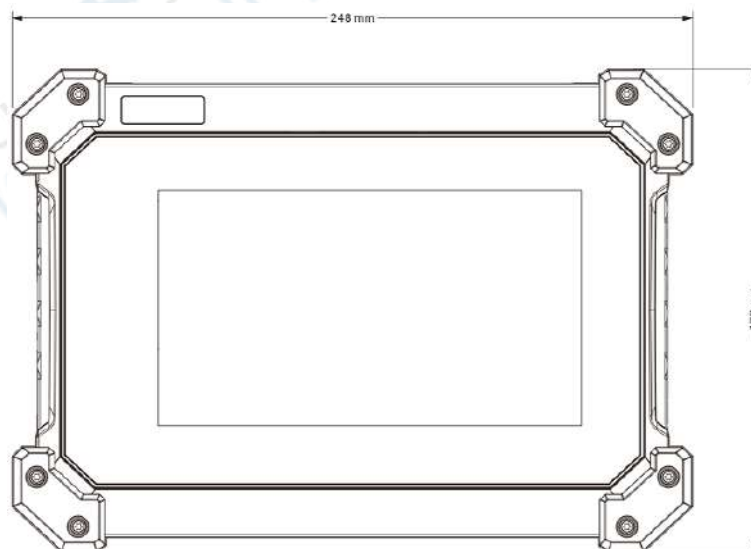

Figure 4.1 Front view4

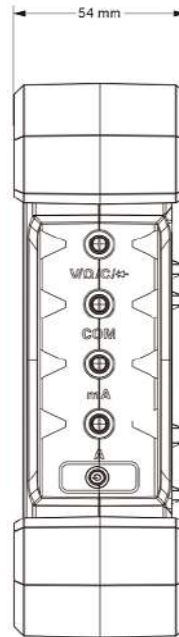

Figure 4.2 Side view

4.3 Preparation before use

4.3.1 Connect the power supply

The oscilloscope is equipped with 4 3.7V 2600 mAh batteries.

Press the power button, the buzzer rings, and the instrument starts up. Press the power button again, the instrument shuts down. Before starting, please make sure the batteries have enough power.



When the battery box on the screen is blank, it indicates that the battery is about to run out.

When the battery level is lower than 3.5V, the oscilloscope will prompt "shut down after 30s". Tap the screen to cancel the popup box. "Shutdown after 20 seconds" and "shutdown after 10 seconds" will appear subsequently. To avoid automatic shutdown due to insufficient power supply, please charge in time.

If the power button is pressed and the buzzer rings continuously but the oscilloscope doesn't respond, it may indicate that the battery power may be exhausted. Please charge in time.

You can charge the oscilloscope in the following ways:

Charge the oscilloscope through the power adapter: connect the oscilloscope to the power socket through the USB data cable and the power adapter in accessories for charging.



When charging, if the machine is not started, the indicator light of the power button will be on. If the machine is turned on, the battery box on the screen will change (slow charge , quick charge ).

When the battery is full, the oscilloscope will stop charging automatically.

4.3.2 Boot check

Press the power button  at the bottom of the right panel to start the instrument.

Shutdown:

- Tap the shutdown icon  at the top of the main interface to shut down directly.
- In the boot state, press the power button  to shut down directly.

4.3.3 Set the system language

This oscilloscope supports Chinese and English. Click **[HOME]** to enter the main interface and click **[Settings] > Language** to select the language.



The default language is English.

4.3.4 Functional check

Click **[OSC]** or tap **[OSC]** in the main interface to enter the oscilloscope interface. Click **Utility > Default** in the lower left corner of the screen to restore the oscilloscope to factory default configurations.

4.3.5 Probe compensation

Security

When using the probe, in order to avoid electric shock, fingers should be kept behind the safety ring. Do not touch the metal part on the top of the probe when the probe is connected to the high voltage power supply. Before any measurement, connect the probe to the oscilloscope and ground the ground end.

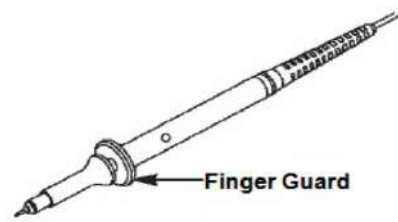

Figure 4.3 Probe41

Manual probe compensation

When the probe is connected to any input channel for the first time, perform this adjustment to match the probe to the input channel. Probes that are not compensated or compensated with bias can lead to measurement errors. To adjust the probe compensation, please follow the following steps:

- 1) Connect one end of the probe to the CH1 channel and the other end to the AFG channel.



- 2) Enter the oscilloscope interface, click **Utility** -> **Probe calibrate**, and set the switch of the probe to 10X as prompted.



- 3) Check the shape of the waveform displayed

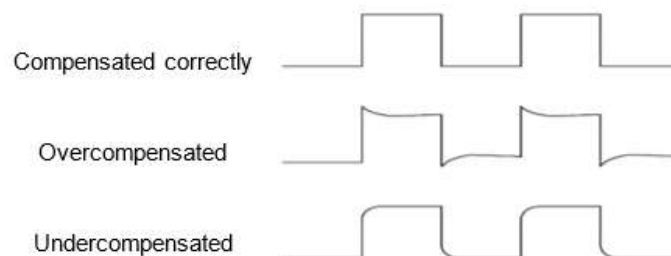

Figure 4.4 Probe compensation4

- 3) If necessary, adjust the variable capacitance on the probe with a non-metallic screwdriver until the waveform displayed on the screen is "compensated correctly" as shown above.

If necessary, repeat Step 3. The adjustment method is shown in the following figure.

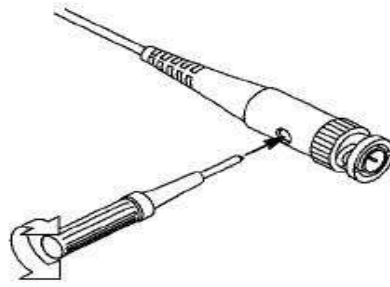

Figure 4.5 Adjust the probe4

4.4 Product introduction

This section introduces the front, rear, side panel and the main interface of the oscilloscope.

4.4.1 Front Panel



Figure 4.6 Front panel

1. Label

Hantek trademark + product model.

2. Virtual keys

The virtual key area on the left of the LCD.

- **[HOME]** : Shortcut key of the main interface. Tap to enter the main interface.
- **[OSC]** : Shortcut key of the oscilloscope. Tap to enter the oscilloscope interface.
- **[DMM]** : Shortcut key of the multimeter. Tap to enter the multimeter interface. If the device does not support the multimeter function, a message will pop up indicating that the multimeter is not supported.
- **[AFG]** : Shortcut key of the signal source. Tap to enter the signal source interface. If the machine does not support the signal source function, a message will pop up indicating that the signal source is not supported.
- **[H/R]** : Pause and run key. Under the oscilloscope function, pause or run waveform update. Under the multimeter function, pause or start measuring data. Under signal generator function, open or close waveform output.
- **[PRINT]** : Screenshot key. Save the current screen to internal memory or external memory.

3. LCD

800*480 resolution LCD.

4.4.2 Rear Panel

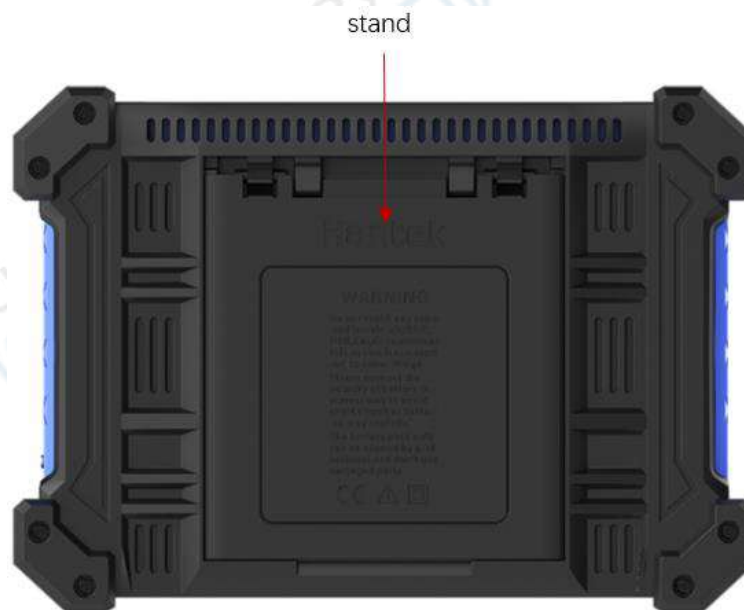

Figure 4.7 Rear view

1. Stand

With the hanging supporting stand, it can be used anywhere.

4.4.3 Side panel

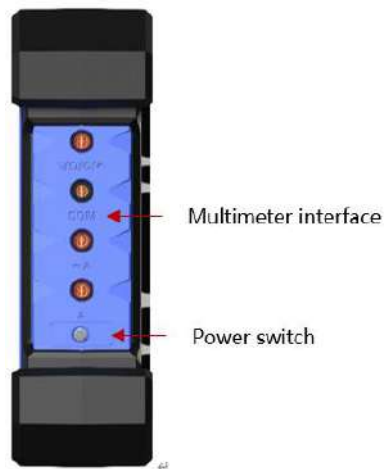

Figure 4.8 Right panel

1. Multimeter interface

V/Ω/C, COM, mA, A. The specific connection mode can be seen on the screen after selecting the gear to be tested.

2. Power switch

When the machine is off, press the power switch to start the machine. Press the power switch again to shut down the machine.

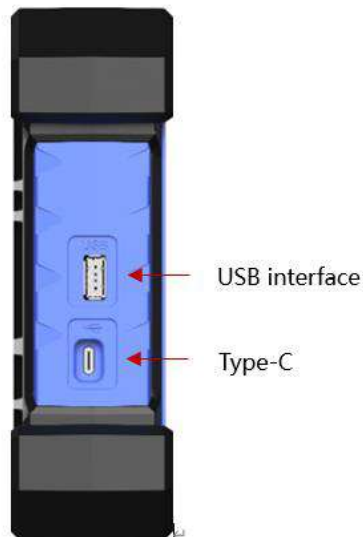

Figure 4.9 Left panel

1. USB interface

This interface connects USB-compatible storage devices to the instrument. Read the waveform file or status file in the USB disk, or save the current instrument state or edited waveform data to the USB disk, or save the current screen as a picture to the USB disk.

2. Type-C

Through this interface, the instrument can be connected to the computer, and the user can connect the upper computer software or send SCPI instructions. This interface is also a charging port, which can charge the machine with the power adapter and USB cable delivered with the accessories. File sharing is also supported. For details about USB Sharing, see section "[Settings](#)".



Figure 4.10 Upper panel

1. Signal source channel

The signal source channel interface outputs different types of waveform. For devices that do not support a signal source, the signal source channel outputs 1KHz square wave signals.

2. CH1 ~ CH4 channels

4 analog channels that connects the probe and analogs signal input.

4.4.4 Main interface

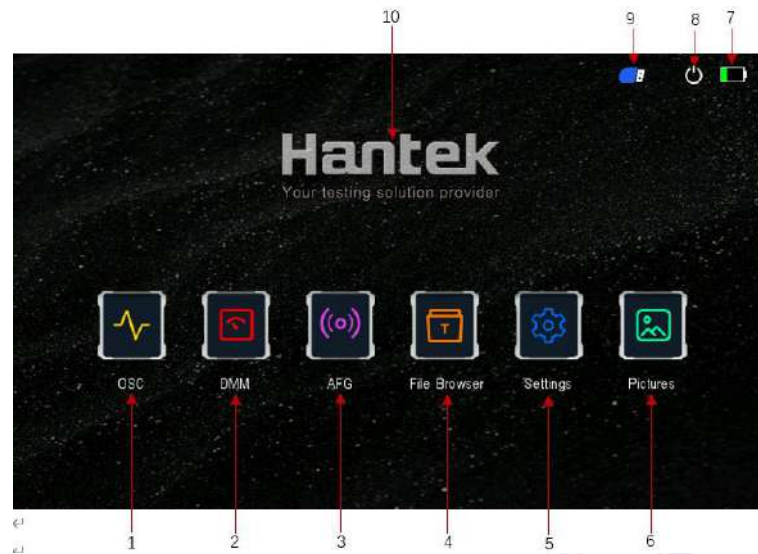

Figure 4.11 Main interface4

- 1 Oscilloscope icon**

Tap to enter the oscilloscope page.
- 2 Multimeter icon**

Tap to enter the multimeter page.
- 3 Signal source icon**

Tap to enter the signal source page.
- 4 File browsing**

Tap to enter the file browsing page. Pictures saved by PRINT and the content saved in the oscilloscope interface will be saved in the file browsing.
- 5 Settings**

Tap to enter the settings page. You can set language, system information, sound, brightness, upgrade, auto lock and USB sharing.
- 6 Gallery**

Tap to enter the gallery page. Pictures saved by PRINT and saved in the oscilloscope interface will be displayed in the file browsing.
- 7 Battery**

Display the battery level in real time.

8 Power switch

After clicking, the machine shuts down.

9 USB disk icon

Plug in the USB disk memory and the icon will be displayed. If no USB flash drive is inserted, the icon will not be displayed.

10 Hantek icon

4.5 Touch screen gesture

This instrument is mainly operated directly on the built-in capacitive touch screen, supporting multi-touch operation, including touching, kneading and dragging. With simple, convenient, flexible and many other characteristics, providing better operation experience.

4.5.1 Touching

Tap a menu or function on the screen with your finger as shown in the following picture.

The functions that touching can achieve are:

- Touch the menu on the screen to operate on the menu.
- Touch the virtual keyboard to set the name of an image or file.
- Touch the numeric keypad and set various parameters.
- Touch various keys, such as close, up, down, etc.



Figure 4.12 Touching gesture

4.5.2 Kneading

Move two fingers together or apart. Kneading gestures allow you to zoom in and out of the waveform. Slide the close fingers apart to enlarge a waveform and slide the separated fingers closer together to shrink a waveform as the following figure shows.

The functions that can be achieved by kneading are:

- Knead vertically to adjust the vertical gear of the waveform.
- Knead horizontally to adjust the horizontal gear of the waveform.

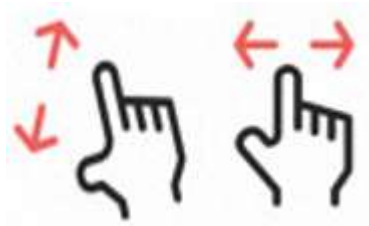

Figure 4.13 Kneading gesture

4.5.3 Dragging

After holding down the target, drag it to the desired position as shown in the following figure. The functions that can be achieved by dragging are:

- Drag the waveform to change the displacement and offset of the waveform.
- Drag the cursor to change the cursor position.
- Drag the trigger to change the trigger position.

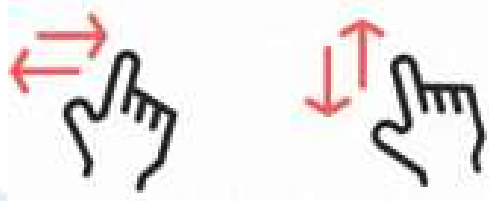

Figure 4.14 Dragging gesture

4.6 Setting parameters

Use the touch screen to set the parameters of the instrument.

Click the parameter to be set, and the virtual keyboard will pop up. Set parameters through the keyboard.

Input a string

When naming a file or folder, you need to enter a string as shown in the following figure.

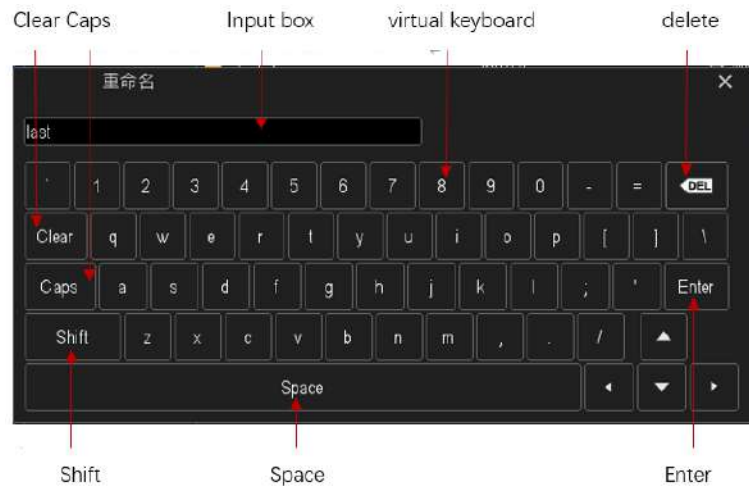

Figure 4.15 Character keyboard

1. Clear the name input box
If the input box does not contain characters, go to the next step. If currently the input box contains characters, click "Delete" key to delete all the characters in sequence or click "Clear" key to remove all characters at a time.
2. Input uppercase letters
To enter an uppercase letter, check whether the letters in the Virtual Keyboard are uppercase. If so, click on the virtual keyboard to enter uppercase letters. Or you can click on the "Caps" key to switch to upper state, then click on the virtual keyboard to input uppercase letters. All input will be displayed in the input box.
3. Type lowercase letters
Refer to the previous step. Lowercase letters are default.
4. Enter a number or symbol
The upper part of the virtual keyboard is digital areas. If you want to input symbols, you can click on the "Shift" key to switch digits into symbols. All input will be displayed in the input box.
5. Modify or delete characters that have been entered
While input, you can modify or delete the entered characters. To delete entered characters, click the "Delete" key or "Clear" key on the virtual keyboard. To modify characters that has been entered, delete the characters and enter the characters again.
6. Input validation
After input, click on the "Enter" button.

Input numerical values

When modifying the parameters, the numeric keypad is used to input the numerical value as shown in the following figure.



Figure 4.16 Numeric keypad

Click on the digits or units in numeric keyboard to input them. After entering all the values and selecting the desired units, the numeric keypad is automatically turned off and the parameter setting is complete. You can also perform the following operations on the numeric keypad:

- Delete entered parameter value.
- Set the parameters to the maximum or minimum (sometimes especially referring to the maximum or minimum value under the current state).
- Set the parameter to the default value.
- Clear the parameter input box.
- Increase or decrease the number. Left and right arrows to determine the number, up and down arrows to increase or decrease the number. Long press the up and down arrows to change the number continuously.

5 Set the horizontal system

This section contains detailed information about oscilloscope horizontal systems. You are advised to read carefully in order to understand its settings, functions and operations.

The following figure shows the sampling rate, storage depth, primary time base and horizontal displacement.

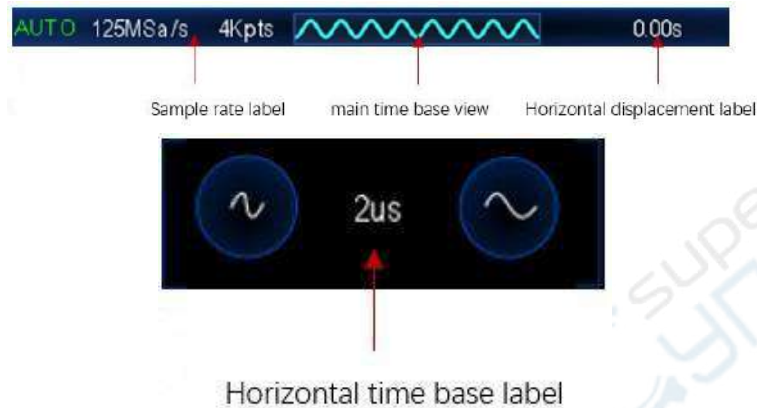

5.1 Adjust the horizontal displacement

Horizontal displacement refers to the displacement of waveform trigger points of all channels in the horizontal direction relative to the center of the screen. When the waveform trigger point is on the left (right) side of the screen center, the horizontal displacement is positive (negative).

When the horizontal displacement is changed, the waveform trigger points and displayed waveforms of all channels move left and right. The horizontal displacement at the top of the screen changes in real time, as shown in the figure below.

0.00s

Adjust the horizontal displacement by touch screen gestures



Adjust the horizontal displacement by dragging. The horizontal trigger position icon  on the screen will move along with your finger slide. You can change the position of the control trigger point relative to the center of the screen while adjusting the horizontal position of the waveforms of all analog channels roughly. For details, see the [Dragging](#) section.

5.2 Adjust the horizontal time base (time/grid)

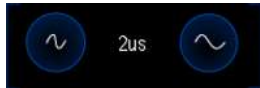
The horizontal time base is the time value represented by each grid in the horizontal direction of the display screen, generally expressed as s/div. If the horizontal time base is changed, the horizontal time base will be displayed in real time as shown below.



Adjust the horizontal time base:

The horizontal time base of all analog channels (current channel) can be adjusted at the bottom. Tap  to increase the time base, and tap  to decrease it. The horizontal time base will be stepped in step size of 1-2-5, and the waveform will change as the time base changes.

Touch to adjust horizontal time base:

Kneading gesture is used to adjust horizontal time base. Please refer to [Kneading](#) chapter for detail.

Set the horizontal time scale to horizontally amplify or compress the waveform. If stopping collecting the waveform, set the "time/grid" will expand or compress the waveform.

5.3 Pan or zoom a single collection or stopped collection

After the oscilloscope stops, the display screen may contain several useful collection data, but you can only pan and zoom the last collected data. Pan and zoom data from a single collection or stopped collection.

6 Set the vertical system

The TO1254D provides four input channels, CH1-CH4, each with an independent vertical control system. The control system of the four channels is the same. This chapter describes how to set CH1. Please read this section carefully to understand the settings, functions and operations of the vertical system.

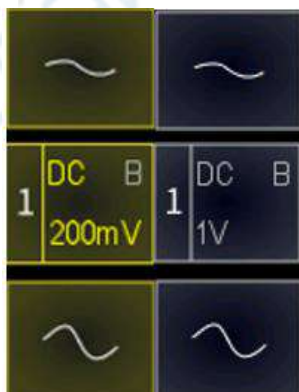

Figure 6.1 Channel vertical menu

6.1 Open or close the analog channel

Tap the channel icon to switch the function: open channel, open channel vertical menu, close channel.



If the channel label is in yellow as shown below, it indicates that the channel is open. If the channel label is gray, it indicates that the channel is closed.



6.2 Adjust the vertical sensitivity

The vertical gear, which is the voltage value represented by each grid in the vertical direction of the display, is usually expressed as V/div. When adjusting the vertical gear, the waveform amplitude will increase or decrease, and the gear information in the channel status label will also change in real time.

Adjust vertical gear:

- Tap the vertical sensitivity labels  or  to the right of the channel icon to adjust the vertical display of waveform of the corresponding channel, so that the waveform can be displayed on the screen with an appropriate size. The vertical sensitivity gear (volt/grid) will be displayed on the channel icon after each adjustment.
- Using the touch screen function, adjust the vertical gear by kneading gesture. Refer to [Kneading](#) section for details.

In the **Vertical channel** menu, you can select "rough adjustment" or "fine adjustment" for the vertical gear. By default, it is rough adjustment. If fine adjustment is checked, fine adjustment will be applied.



- Fine adjustment: After selecting fine adjustment, the vertical gear will change in a smaller range, which is conducive to observing signal details.
- Rough adjustment: Change the vertical gear. The vertical sensitivity of the analog channel is adjusted by the vertical sensitivity coefficient in 1-2-5 step size (probe attenuation coefficient is 1X). The range of the vertical sensitivity of 1:1 probe is 2mV/div-10V/div.

6.3 Adjust the vertical offset

Vertical offset refers to the offset in vertical direction of the zero point of the channel signal with respect to the center of the screen. The unit is the same as the currently selected amplitude unit. When adjusting the vertical offset, the waveform of the corresponding channel moves up and down.

The offset information is shown as follows:



Adjust the vertical offset:

Use the touch screen function to adjust the vertical offset by dragging gestures. For details, see the [Dragging](#) section.

In the **Vertical channel** menu, increase or decrease the offset by tapping the arrow icon

next to the value box as shown in the figure below.



6.4 Channel coupling

Set the coupling mode to filter out unwanted signals. Open **Vertical channel > Coupling** to select the coupling mode as shown in the figure below.



- When the coupling mode is "DC", both DC and AC components of the measured signal can pass through.
- When the coupling mode is "AC", the DC component of the measured signal is blocked.
- When the coupling mode is "Grounded", the DC and AC components of the measured signal are blocked.

After the coupling mode is set, the current coupling mode is displayed in the channel label, as shown in the figure below.

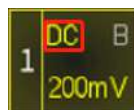

6.5 20M bandwidth limit

This oscilloscope supports bandwidth limit. Setting bandwidth limit can reduce noise in the display waveform. For example, the signal being measured is a pulse signal with high frequency oscillations.

- When the bandwidth limit is turned off, the high frequency component of the measured signal can pass through.
- If the bandwidth limit is turned on and restricted to 20 MHz, the high frequency components larger than 20 MHz in the measured signal are attenuated.

Open **Vertical channel > BW limit** and select a bandwidth limit. The default state of bandwidth limit is off. After it is enabled, the color of B on the channel label is the same as that of the channel as shown in the figure below.



6.6 Waveform inversion

Open **Vertical channel** > **Invert** to turn on the waveform inversion function, which is disabled by default.



When the waveform inversion is disabled, the waveform is displayed normally. When waveform inversion is turned on, the voltage value of the waveform is inverted as shown in the figure below. Turning on waveform inversion will also change the results of mathematical operations, waveform measurements, and other operations.



Figure 6.2 Waveform inversion

6.7 Probe

Open **Vertical channel** > **Probe**.



The oscilloscope allows the user to set the probe attenuation ratio manually. The user must set the probe ratio correctly to obtain accurate measurement results. The default probe ratio is 1X, and the probe range is 0.01X-10000X.

In order to match with the attenuation ratio of the probe in use, it is necessary to adjust the corresponding channel attenuation ratio under the channel menu. Whenever the probe attenuation ratio changes, it is necessary to set the corresponding attenuation ratio to ensure the correctness of oscilloscope waveform amplitude and measurement results.

6.8 Amplitude unit

Open **Vertical channel** > **Unit**. The optional units are voltage and current. The default unit is voltage.

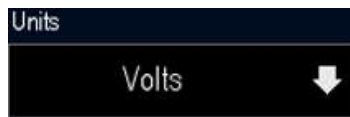

When the amplitude unit is changed, the unit of related functions are also changed.

7 Mathematical operations

This series of oscilloscopes supports various mathematical operations between analog channel waveforms, including addition (+), subtraction (-), multiplication (*), division (/) and FFT.

Tap **Next** > **MATH** in the lower left corner of the screen.



Figure 7.1 Math operation menu

7.1 Algebraic operation

The algebra operations supported in the **MATH** menu are addition, subtraction, multiplication, and division.

Addition: Add the signals from data sources 1 and 2 point by point and display the results.

Subtraction: Subtracts the signals from data sources 1 and 2 point by point and displays the results.

Multiplication: Multiply the signals from data sources 1 and 2 point by point and display the results.

Division: Divide data source 1 and data source 2 signals point by point and display the results.

Offset

To adjust the vertical displacement of the waveform of the function, please refer to the section [Adjusting the vertical offset](#), or directly click the numeric keypad to set the value. For detail, please refer to the section [Setting parameters](#).

Data source

Data source 1: Select data source CH1 to CH4 to perform the operation.

Data source 2: Select data source CH1 to CH4 to perform the operation.

Algebraic operations, taking addition as an example:

1. Tap the **MATH** channel icon to enter the **MATH** menu.
2. Select “+” to perform addition.
3. Select data sources 1 and 2.
4. A mathematical operation waveform appears on the screen and is labeled "M".
5. Change the offset by sliding the operation waveform. Or set the offset directly in the menu.

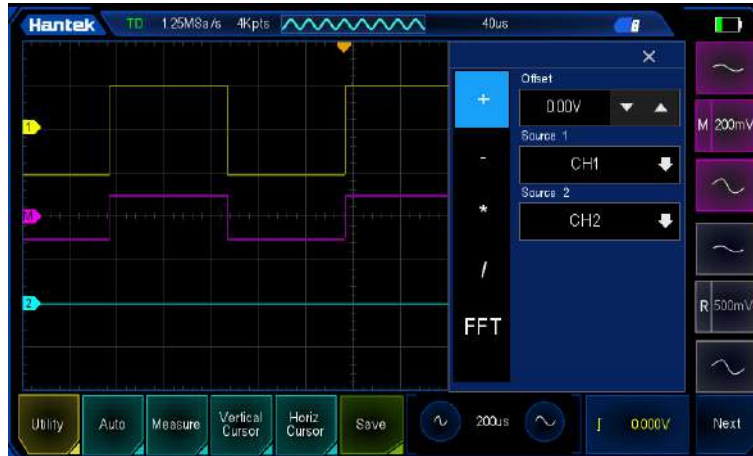

Figure 7.2 Addition operation

7.2 FFT operation

Use FFT to convert the time domain (YT) signal to the frequency domain for the selected data source. The vertical axis shows amplitude (in decibels or VRms) and the horizontal axis shows frequency.

Data source

Select the data source CH1 to CH4 to perform the calculation.

Vertical units

Select the unit of the vertical scale, VRms or dB.

Window

Applied to FFT Window functions. Including: Hanning, Hemming, Brackman, Bartlett, flat top, rectangular.

Hanning: Good frequency resolution, poor amplitude resolution. Used for measuring periodic waveform.

Hamming: Slightly better than the hanning window in frequency resolution. Used for measuring transient and short pulse waveforms.

Brackman: Best amplitude resolution, worst frequency resolution. Used for measuring single frequency signals and search for higher harmonics.

Bartlett: Good frequency resolution. Used to measure strong signals with narrow bandwidth.

Flat top: Good amplitude resolution, poor frequency resolution. Used to measure

periodic waveform.

Rectangle: A dedicated window for a discontinuous waveform, similar to the case without a window. Used for measuring transient and short pulse waveforms.

Center

The FFT (amplitude) frequency waveform at the central grid line.

Span

The frequency span of the FFT (amplitude) waveform displayed on the screen.

Reference level

The reference level position of the FFT (amplitude) waveform.

FFT operation:

1. Tap the MATH channel icon to access the **MATH** menu.
2. Select **FFT** and perform FFT operation.
3. Select data source and click the arrow to select CH1~CH4.
4. Select the vertical unit and click the arrow to select dB or VRms.
5. Select the FFT function and click the arrow to select different window functions.
6. Set the frequency of frequency domain waveform corresponding to the horizontal center of the screen, click the arrow for fine adjustment, or click the data and input the value on the digital keyboard popping up.
7. To set the frequency span, click the arrow and select 62.50KHz or 31.25KHz.
8. To set the reference level, click the arrow for fine adjustment, or click the data, input the value on the popping up numeric keypad.

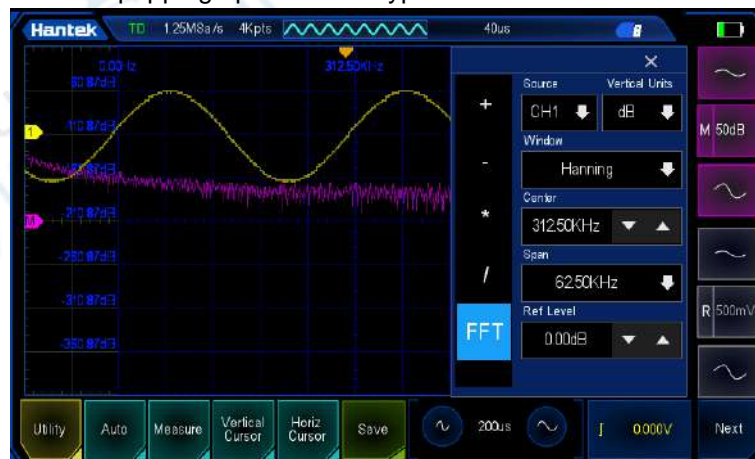

Figure 7.3 FFT operation

A signal with a DC component or deviation will result in an error or deviation of the FFT waveform component. To reduce the DC component, set the "Channel coupling" of the data source to "AC" mode.

In order to reduce the random noise and aliasing frequency component of repeated or

single pulse events, the "Acquisition mode" of oscilloscope can be set to "Average" mode.

Use cursor to measure FFT waveform

To perform cursor measurement, tap the vertical or horizontal cursor at the bottom of the interface. Use the AX and BX cursors to measure the frequency and the difference between the two frequencies (BX-AX). Use the AY and BY cursors to measure the amplitude and amplitude difference (BY-AY). For details, see the [Cursor measurement](#) section.

8 Reference channel

Save reference waveform

Click **Utility** > **Save** > **Ref wave**, then select reference data sources CH1~CH4. Click the save icon below to open the **Reference waveform** menu, you can see the reference waveform saved just now.

If a USB flash drive is inserted, then the reference waveform will be saved to the USB flash drive. It is also necessary to plug in the USB disk to call the reference waveform in the USB disk.

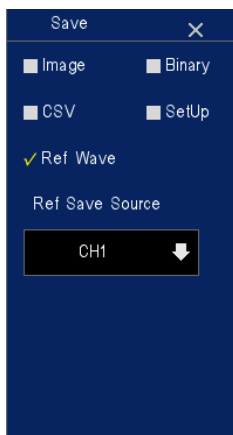

Reference waveform calling and closing

This series of oscilloscopes support calling reference waveform.

On the oscilloscope interface, click **Next** > **Reference waveform**.

If the reference waveform has been saved before, open the reference waveform menu and the reference waveform file will be displayed.

Click to select a reference waveform file, and a pop-up box will prompt: Call out successfully.

A gray reference waveform will appear on the screen.

Click the yellow bar , it will turn gray, indicating the reference waveform is closed.

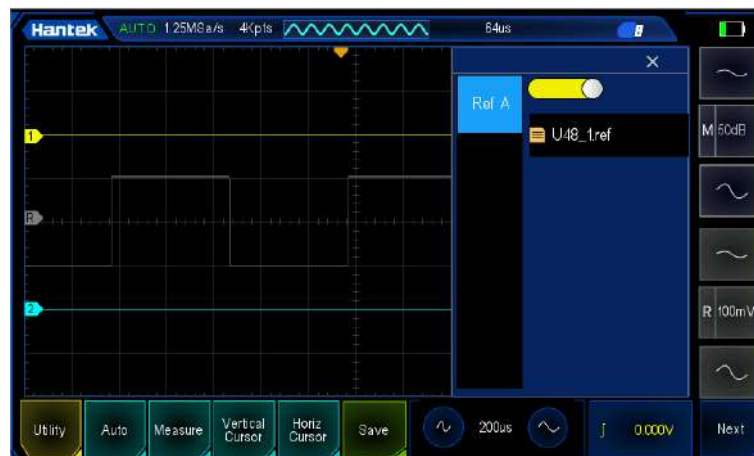

Figure 8.1 Reference waveform

Reference waveform movement and time base adjustment

Horizontal and vertical movement and scaling of the reference waveform are independent of each channel.

The method of adjusting the horizontal or vertical position of the reference waveform is the same as adjusting the channel. For details, refer to [Set the horizontal system](#) and [Set the vertical system](#).

9 Trigger oscilloscope

Triggering refers to setting certain triggering conditions according to requirements, when a certain waveform in the waveform stream meets this condition, the oscilloscope will capture the waveform and its adjacent parts immediately and display them on the screen. The trigger determines when the oscilloscope begins to acquire data and display the waveform. Once the trigger is properly set, an oscilloscope can convert an unstable display or blank screen into a meaningful waveform. Here are some basic concepts of triggers.

Trigger sources: Triggers can be generated by multiple data sources. The most common one is the input signal (CH1 to CH4). Trigger can be executed normally regardless of whether the input signal is displayed. In addition, the trigger source can be any signal connected to an external trigger channel (for edge triggers only).

Click the trigger icon at the bottom of the screen to enter the [Trigger](#) menu.



9.1 Trigger level

Trigger level

Trigger level is the signal voltage corresponding to the set trigger point.

The trigger flag and the trigger level line move up and down as the trigger level changes. The color of the trigger flag is consistent with the channel color. When changing the trigger level, a horizontal dotted line will temporarily appear on the screen to tell you where the level is (the specific value of the trigger level is displayed on the trigger menu tab). The trigger level line disappears about 2s after stopping modifying the trigger level.



In addition, if the last operation is to adjust the trigger level, click [Trigger](#) > [50%](#), the trigger level can be adjusted to 50% of the amplitude of the trigger source channel waveforms.

Adjust the trigger level using the touch screen function. For details, see [Dragging](#) section.

9.2 Trigger data source

Open [Trigger](#) > [Source](#) and select the data source. Available data sources are CH1 ~ CH4. The selected channel works whether it is opened or not.

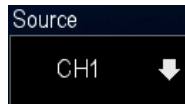

9.3 Trigger mode

Oscilloscope trigger mode includes normal, automatic, single trigger. The default mode is automatic.

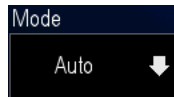

- Normal mode: The display waveform is updated only when the oscilloscope has a valid trigger. The oscilloscope will display the original waveform before replacing it with a new one. Use normal mode when you only want to see valid triggered waveforms. Under this mode, the oscilloscope displays the waveform only after the first trigger.
- Automatic mode: Acquisition can be performed automatically without a valid trigger. This mode allows untriggered scan waveforms to occur at a time base setting of 100 ms/grid or slower. When the oscilloscope detects a valid trigger, a trigger acquisition is performed. When the oscilloscope detects that there is no valid trigger, a none-trigger acquisition is performed.
- Single trigger mode: Enter the stop state after the acquisition only when the oscilloscope has a valid trigger.

Forced trigger: Under normal and single trigger mode, click the forced trigger button in the trigger menu to force a trigger signal.

When not getting enough knowledge of the feature of a signal, set in "automatic" mode to ensure that the oscilloscope has waveform display when other trigger settings are not correct. Although the waveform may not be stable, it can provide intuitive judgment for further adjustment.

When we set a specific trigger condition for a specific signal, especially when the time interval meeting the trigger condition is long, set the trigger mode to "normal" to prevent the oscilloscope from automatically performing forced trigger.

9.4 Trigger hold-off

Trigger hold-off time indicates the time that oscilloscope waits from triggering to re-connecting the trigger circuit. During the hold-off period, the oscilloscope does not re-trigger until the hold-off time is over, hence, setting hold-off time can trigger complex waveforms stably. The trigger hold-off time ranges from 8ns to 10s.

The hold-off can be triggered on repeated waveforms that have multiple edges (or other events) between themselves. If the minimum time between triggers is known, you can also use hold-off to trigger on the first edge of the trigger.

For example, to obtain stable triggers on the repeated pulse trigger shown below, the hold-off time can be set to a value $> 200\text{ns}$ but $< 600\text{ns}$.



Figure 9.1 Trigger hold-off

Set trigger hold-off time:

- Click **Trigger** > **Holdoff**, click the arrow to the right of the value, adjust to the appropriate value.
- Click **Trigger** > **Holdoff**, directly click trigger hold-off value, and the numeric keyboard will appear. Input the value in the numeric keyboard.

Trigger hold-off operation reminder

Usually used for complex waveforms. The correct hold-off setting is usually slightly less than one repeat of the waveform. Setting the hold-off time to this time generates a unique trigger point for the repeated waveform.

Changing the time base does not affect the trigger hold-off time.

Tap "H/R" to stop and then pan and scale to find where the waveform repeats. Use the cursor to measure this time, and then set the hold-off time.

9.5 Trigger type

9.5.1 Edge-triggered

Edge trigger types identify triggers by looking for the specified edge (rising edge, falling edge, double edge) and voltage level on the waveform.

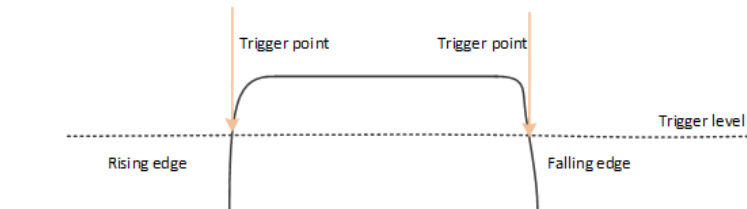

1. Click the trigger area in the lower right corner of the screen to enter the **Trigger** menu.
2. Click the **Edge** on the left side of the menu.
3. Click **Source** and select CH1 ~ CH4 as the trigger source. CH1 to CH4: analog channel.
4. Click **Mode** and select the trigger mode (automatic, normal, single).

5. Click **Holdoff** to adjust the trigger hold-off.
6. Click **Slope** and select the required trigger edge (rising, falling, double).
Rising: Signal rising edge trigger.
Falling: Signal falling edge trigger.
Double: Signal rising or falling edge trigger.
7. Adjust the trigger by sliding to obtain a stable trigger.

Note: The automatic setting button will set trigger type as edge trigger and trigger slope as rising edge.

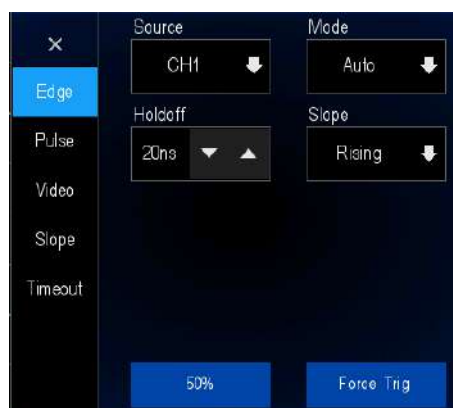
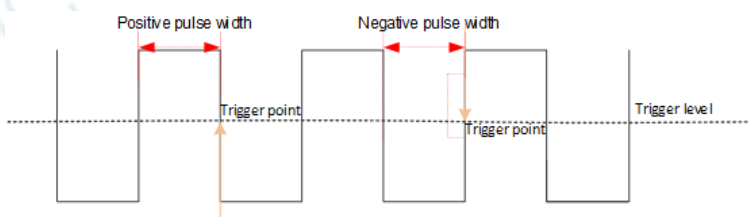

Figure 9.2 Edge trigger menu

9.5.2 Pulse width trigger

Pulse-width trigger triggers on positive or negative pulses of specified width. Trigger source, polarity (positive pulse width, negative pulse width), limiting conditions and pulse width can be set in this menu.



1. Click the trigger area in the lower right corner of the screen to enter the **Trigger** menu.
2. Click the **Pulse** on the left side of the menu.
3. Click **Source** and select CH1 ~ CH4 as the trigger source.
4. Click **Mode** and select trigger mode (automatic, normal, single).
5. Click **Holdoff** to adjust the trigger hold-off.
6. Click **Polarity** and select trigger polarity (positive and negative).
Positive: Triggered when a signal with positive polarity pulse width occurs.
Negative: Triggered when a signal with negative polarity pulse width occurs.
7. Click **When** and select the trigger condition.

< (less than the time value): Triggered when the positive or negative pulse width of the input signal is less than the set pulse width.

For example, for a positive pulse, if t (the actual width of the pulse) is set to $< 100\text{ns}$, the waveform triggers.



> (greater than the time value): Triggered when the input signal positive pulse or negative pulse width is greater than the set pulse width.

For example, for a positive pulse, if t (the actual width of the pulse) is set to $> 100\text{ns}$, the waveform triggers.



!= (not equal to the time value): Triggered when the input signal positive pulse or negative pulse width is not equal to the set pulse width.

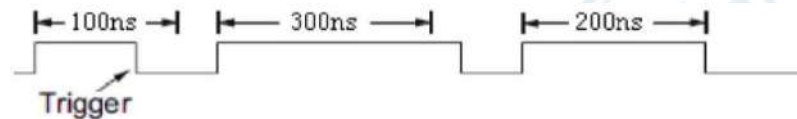

= (equal to time value): Triggered when the input signal positive pulse or negative pulse width is equal to the set pulse width.

For example, for a positive pulse, if t (actual pulse width) is set to be $=200\text{ns}$, the waveform triggers.

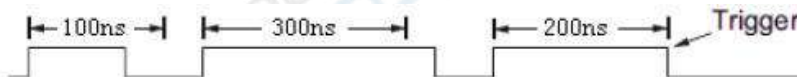

- Click **Width** to set the reference width of the pulse signal.

The pulse width of the data source must be $\geq 5\text{ns}$ in order for the oscilloscope to detect the pulse.

$=, \neq$: Within $\pm 5\%$ tolerance, oscilloscope will be triggered when the pulse width of the signal is equal to or not equal to the specified pulse width.

$<, >$: The oscilloscope will be triggered when the pulse width of the data source signal is less than or greater than the specified pulse width.



Figure 9.3 Pulse width trigger menu

9.5.3 Video trigger

Video triggers can be used to capture complex waveforms of most standard analog video signals as well as HD video signals. The trigger circuit can detect the vertical and horizontal intervals of the waveform and generates a trigger based on the selected video trigger setting. This series of oscilloscopes supports NTSC (National Television Standards Committee) and PAL.

1. Click the trigger area in the lower right corner of the screen to enter the **Trigger** menu.
2. Click **Video** on the left side of the menu.
3. Click **Source** and select CH1 ~ CH4 as the trigger source.
4. Click **Mode** and select trigger mode (automatic, normal, single).
5. Click **Holdoff** to adjust the trigger hold-off.
6. Click **Standard** and select the desired video standard. This series of oscilloscopes support video standards: NTSC, PAL, HDTV720p, HDTV1080p, HDTV1080i.
7. Click **Sync**, select the required field or line (scan line, line number, odd field, even field, all fields) to trigger the signal.
8. Click **Line No.** to set the line number in the field to trigger.
9. Click **Polarity** and select the trigger polarity (positive and negative).
Positive: Triggered when a signal with positive polarity pulse width occurs.
Negative: Triggered when a signal with negative polarity pulse width occurs.

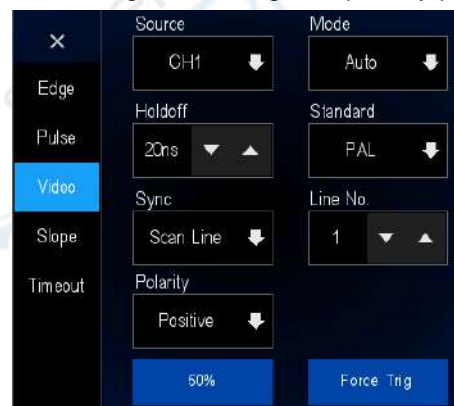
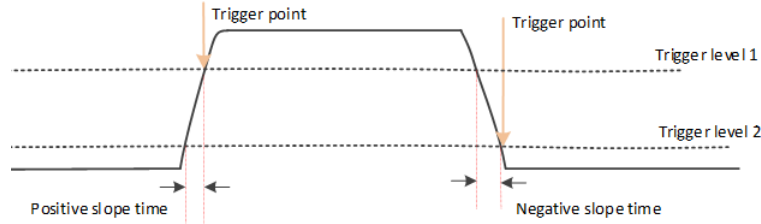

Figure 9.4 Video trigger menu

9.5.4 Slope trigger

Slope trigger sets the positive or negative slope trigger of the oscilloscope from one level to another within a specified period of time.

As shown in the figure below, the time difference between the two points (A and B) where the high and low trigger levels intersect the rising (falling) edge of the waveform is defined as the positive (negative) slope time.



1. Click the trigger area in the lower right corner of the screen to enter the **Trigger** menu.
2. Click **Slope** on the left side of the menu.
3. Click **Source** and select CH1 ~CH4 as the trigger source.
4. Click **Mode** and select trigger mode (automatic, normal, single).
5. Click **Holdoff** to adjust the trigger hold-off.
6. Click **Slope** and select trigger edge (rising, falling).
Rising: Signal rising edge trigger.
Falling: Signal falling edge trigger.
7. Click **When** and select the desired slope condition.
< (less than time value) : Triggered when the positive or negative slope time of the input signal is less than the set time value.
> (greater than time value) : Triggered when the positive or negative slope time of input signal is greater than the set time value.
!= (not equal to time value) : Triggered when the positive or negative slope time of the input signal is not equal to the set time value.
= (equal to time value) : Triggered when the positive or negative slope time of the input signal is equal to the set time value.
8. Click **Time** to set the reference value of slope time.



Figure 9.5 Slope trigger menu

9.5.5 Timeout trigger

Trigger when the time interval (ΔT) from the rising edge (or falling edge) of the input signal passing through the trigger level to the adjacent falling edge (or rising edge) passing through the trigger level is greater than the set timeout time. As shown below:

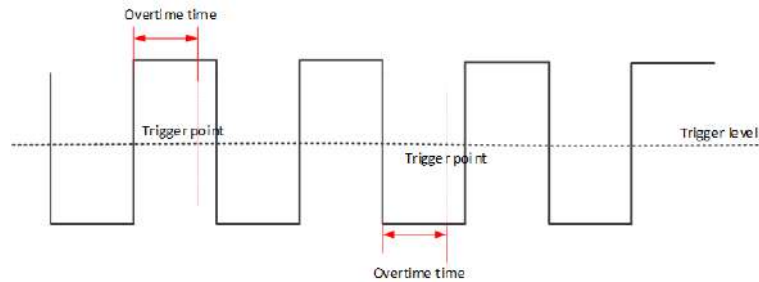

1. Click the trigger area in the lower right corner of the screen to enter the **Trigger** menu.
2. Click **Timeout** on the left side of the menu.
3. Click **Source** and select CH1 ~ CH4 as the trigger source.
4. Click **Mode** and select trigger mode (automatic, normal, single).
5. Click **Holdoff** to adjust the trigger hold-off.
6. Click **Polarity** to select positive or negative polarity trigger.
 Positive polarity: Start timing when the rising edge of the input signal passes through the trigger level.
 Negative polarity: Start timing when the falling edge of the input signal passes through the trigger level.
7. Click **Time** to set a reference value for the timeout period.

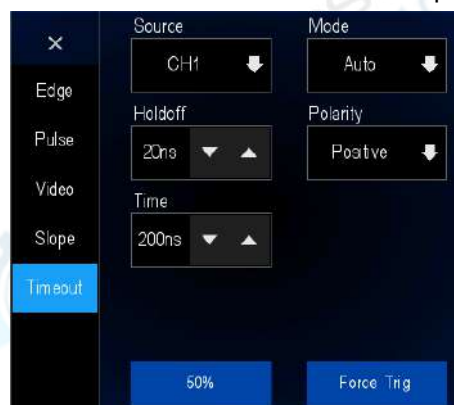

Figure 9.6 Timeout trigger menu

10 Measure

The voltage - time diagram displayed can be used to measure the displayed waveform in many ways such as using screen grid scale, cursors or automatic measurements.

Click **Measure** at the bottom of the screen to enter the measurement menu.

10.1 Grid scale measurement

Grid scale: This method can be used to quickly and intuitively estimate the frequency and voltage amplitude of the waveform. Simple measurements can be made by the division and scale coefficient of the grid graph.

For example, you can calculate the relevant primary and secondary scale division and multiply them by a scaling factor to make simple measurements. If it is calculated that there are six main vertical scale divisions between the maximum and minimum values of the waveform, and the scaling coefficient is known to be 50mV/division, the peak-to-peak voltage can be calculated as follows:

$$6 \text{ divisions} \times 50\text{mV/division} = 300\text{mV}$$

10.2 Measurement parameters

Click **Measure** to perform the measurement function. 42 automatic measurements are provided. Follow the following steps for automatic measurement.

- Click the **Measure** key at the bottom of the oscilloscope interface.
- Click **Source** and select channel CH1~CH4.
- Click to select the desired measurement parameter, and click OK.
- After the measurement parameter is added, the measurement parameter and the value will be displayed in the directory, and will be updated in real time.
- To cancel the measurement parameter, click the measurement item again, or click “Clear all”.

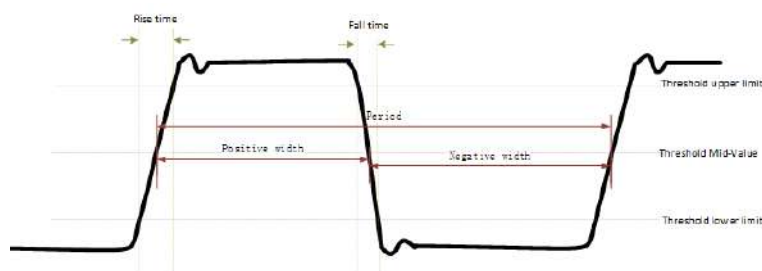

Figure 10.1 Measurement parameters

The measurement display area can display up to 32 measurement parameters, and the measurement is carried out according to the selection order. If a 33rd measurement parameter is added, the first measurement parameter will be deleted.

Note: If the parameter does not match the measurement condition, “**” will be displayed.**

10.2.1 Time parameters



1. Period: Defined as the time between the mid-threshold intersection of two continuous, homopolar edges.
2. Frequency: Defined as the reciprocal of the period.
3. Rising time: The time that the signal amplitude rises from the lower limit to the upper limit of the threshold.
4. Falling time: The time that the signal amplitude decreases from the upper limit to the lower limit of the threshold.
5. Positive pulse width: The time difference between the threshold midpoint of the rising edge of the pulse and the threshold midpoint of the following falling edge.
6. Negative pulse width: The time difference between the threshold midpoint of the falling edge of the pulse and the threshold midpoint of the following rising edge.
7. Positive duty cycle: The ratio of positive pulse width to period.

$$+Duty = \frac{\text{positive pulse}}{\text{period}} \times 100\%$$

8. Negative duty cycle: The ratio of negative pulse width to period.

$$-Duty = \frac{\text{negative pulse}}{\text{period}} \times 100\%$$

9. Pulse width: Time from the first edge of the data source to the last edge.
10. Maximum time: The time value corresponding to the maximum waveform (V_{max}).
11. Minimum time: The time value corresponding to the minimum waveform (V_{min}).

Note: The upper threshold, middle threshold and lower threshold are 90%, 50% and 10% respectively.

10.2.2 Count parameters

1. Positive pulse number: The number of positive pulses rising from below the lower threshold to above the upper threshold.

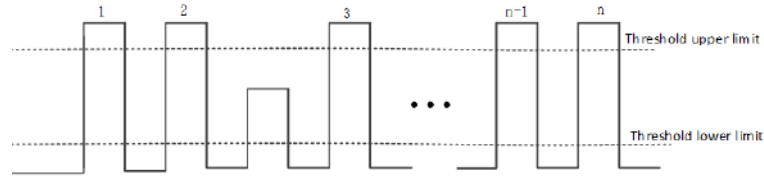

2. Number of negative pulses: The number of negative pulses falling from above the upper threshold to below the lower threshold.

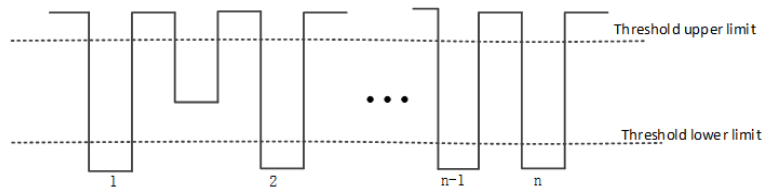

3. Number of rising edges: The number of rising edges rising from below the lower threshold to above the upper threshold.

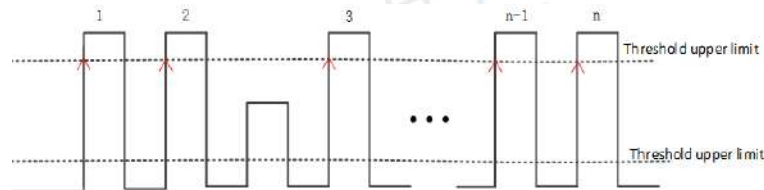

4. Number of falling edges: The number of falling edges falling from above the upper threshold to below the lower threshold.

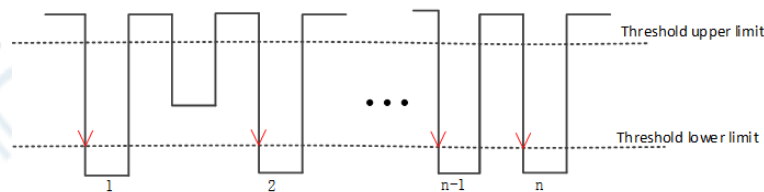

5. Trigger count: The number of rising edges (or falling edges).

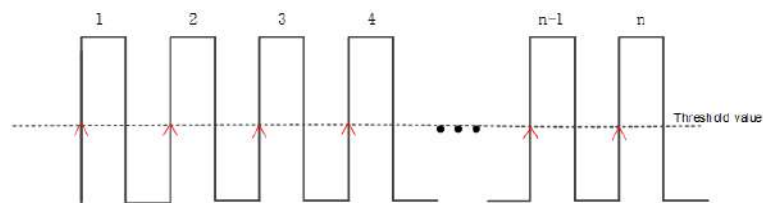

Note: The above measurements only apply to analog channels. The upper and lower thresholds are 90% and 10% respectively.

10.2.3 Delay and phase parameters

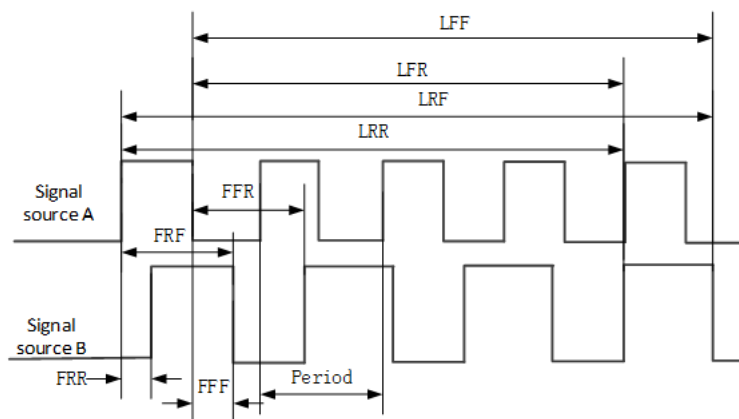

Data sources A and B, i.e., data sources A and B in the measurement settings menu, can be any channel in CH1- CH4.

1. FRR[First Delay Rise-Rise]: $\uparrow A \rightarrow \uparrow B$, indicates the time difference between the first rising edge of data source A and B.
2. FFF[First Delay Fall-Fall]: $\downarrow A \rightarrow \downarrow B$, indicates the time difference between the first falling edge of data source A and B.
3. FRF[First Delay Rise Fall] : $\uparrow A \rightarrow \downarrow B$, the time difference between the first rising edge of data source A and the first falling edge of data source B.
4. FFR[First Delay Fall Rise] : $\downarrow A \rightarrow \uparrow B$, the time difference between the first falling edge of data source A and the first rising edge of data source B.
5. LRR[Last Delay Rise-Rise]: $\uparrow A \rightarrow \uparrow B$, indicates the time between the first rising edge of data source A and the last rising edge of data source B.
6. LRF[Last Delay Rise Fall] : $\uparrow A \rightarrow \downarrow B$, indicates the time between the first rising edge of data source A and the last falling edge of data source B.
7. LFR[Last Delay Fall Rise] : $\downarrow A \rightarrow \uparrow B$, indicates the time between the first falling edge of data source A and the last rising edge of data source B.
8. LFF[Last Delay fall-fall] : $\downarrow A \rightarrow \downarrow B$, indicates the time between the first falling edge of data source A and the last falling edge of data source B.
9. Positive phase difference [R-PhaseAB]: the phase difference between the rising edges of the channels.
10. Negative phase difference [F-PhaseAB] : the phase difference between the falling edges of the channels.

[Phase Rise Time]: $\uparrow A \rightarrow B$, the phase difference is calculated according to the period of "delay 1->2" and data source 1, expressed in degrees. The phase calculation formula is:

$$\text{Phase} = \frac{\text{Delay}}{\text{period1}} \times 360^\circ$$

Phase indicates phase $\uparrow A \rightarrow B$ or phase $\downarrow A \rightarrow B$.

Delay indicates delay FRR or delay FFF.

Period1 refers to the period of the digital data source 1.

10.2.4 Voltage parameters

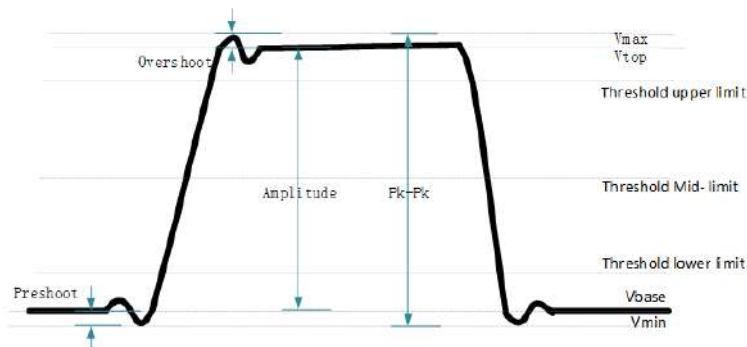

1. [Vmax] : voltage from the highest point of the waveform to GND.
2. [Vmin] : voltage from the lowest point of the waveform to GND.
3. [PK-PK] : voltage from the highest point to the lowest point of the waveform.
Double peak = Vmax - Vmin
4. [Vtop] : the voltage from the waveform flat top to GND.
5. [Vbase] : the voltage from the waveform bottom to GND.
6. [Vamp] : the voltage value from top to bottom of the waveform.
Amplitude = Vtop - Vbase
7. [Vmid] : the actual voltage corresponding to the middle value of the threshold.
8. [Average]: the arithmetic average over the entire waveform or gating region.
9. [Per-average]: the arithmetic average of the first period of a waveform.

$$\text{Average} = \frac{\sum x_i}{n}$$

Where x_i is the measurement result of the i th point, and n is the number of points measured.

10. [Vrms] : root mean square value over the entire waveform or gated region.
11. [Per-Vrms] : the root mean square value within a period.

$$\text{RMS} = \sqrt{\frac{\sum_{i=1}^n x_i^2}{n}}$$

Where x_i is the measurement result of the i th point, and n is the number of points measured.

12. [Rise Overshoot]: The ratio of the difference between the maximum value and the top value of a waveform to its amplitude.
13. [Fall Pre-shoot]: The ratio of the difference between the minimum and the bottom value of the falling edge of a waveform to its amplitude.
14. [Fall Overshoot]: The ratio of the difference between the maximum value and the top value of the falling edge of a waveform to its amplitude.
15. [Rise Pre-shoot]: The ratio of the difference between the minimum value and the bottom value of the waveform to the amplitude.
16. [Variance]: The average sum of the squares of the difference between the amplitude of each waveform point over the entire waveform or gating region and the mean

value of the waveform. The variance shows how much the waveform fluctuates. The calculation formula is as follows:

$$\text{Variance} = \frac{\sum_{i=1}^n (\text{Vamp}(i) - \text{Average})^2}{n}$$

Where Vampi is the amplitude value of the ith point, Average is the average value of the waveform, and n is the number of points measured.

10.3 Cursor measurement

Cursor: This method allows the user to take measurements by moving the cursor. Cursors always appear in pairs, and the readings displayed are the measured values. There are two types of cursors: vertical and horizontal.

Horizontal cursor: The amplitude cursor, displayed as a horizontal dashed line, is used to measure parameters in the vertical direction.

Vertical cursor: The time cursor, displayed as a vertical dashed line, is used to measure parameters in the horizontal direction.

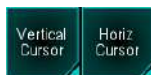

10.3.1 Vertical Cursor

The tracking cursor is displayed as a vertical line on the screen that can measure the vertical parameters of the waveform.

The operation steps are as follows:

- Click the **Vertical Cursor**.
- The Vertical line appears on the screen.
- Drag the vertical line to the position you want to measure.
- The measurement results are displayed in the upper left corner of the screen.

Vertical cursor display window:

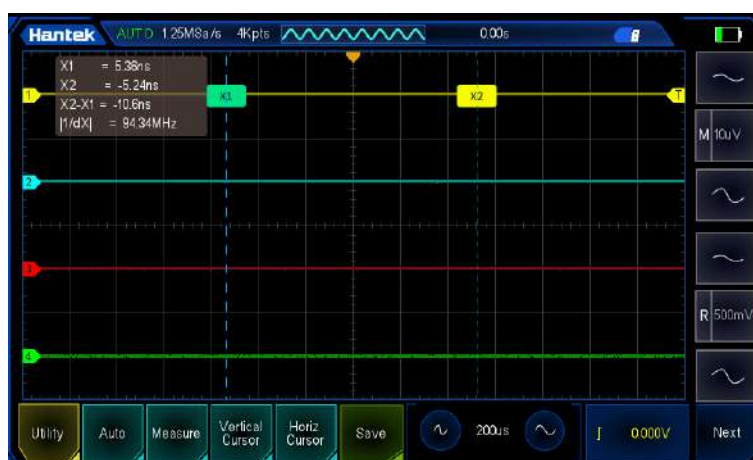

Figure 10.2 Vertical cursor

The X cursor is a vertical dashed line for horizontal adjustment that can be used to measure time (s) and frequency (Hz).

X1 is the cursor AX, X2 is the cursor BX.

AX: the X value at the cursor X1.

BX: the X value at the cursor X2.

BX-AX: horizontal spacing between cursor X1 and cursor X2.

$|1/dX|$: the reciprocal of the horizontal spacing between cursor X1 and X2 cursor.

Vertical cursor movement

Use the touch screen function to adjust the cursor position by dragging gestures. For details, see [Dragging](#) section.

10.3.2 Horizontal Cursor

The horizontal cursor displays a horizontal line on the screen that measure the horizontal parameters of the waveform.

The operation steps are as follows:

- Click the **Horiz Cursor**.
- The horizontal line appears on the screen.
- Drag the horizontal line to where you want to measure it.
- The measurement results are displayed in the upper left corner of the screen.

Horizontal cursor display window:

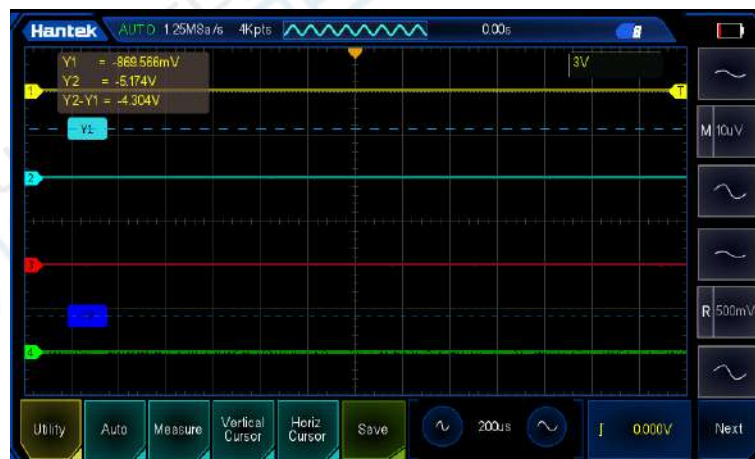

Figure 10.3 Horizontal cursor

The Y cursor is a horizontal dashed line for vertical adjustment that can be used to measure the amplitude (in the same unit as the source channel amplitude).

Y1 is the cursor AY, Y2 is the cursor BY.

AY: Y value at cursor Y1.

BY: Y value at cursor Y2.

BY-AY: Vertical spacing between cursors Y1 and Y2.

Horizontal cursor movement

Use the touch screen function to adjust the cursor position by dragging gestures. For details, see [Dragging](#) section.

11 Acquisition

Click **Utility** > **Acquire** in the lower left corner of the screen to open the acquisition menu.

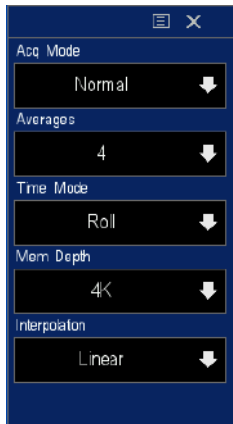

11.1 Acquisition mode

There are four acquisition modes: normal, average, peak and high resolution.

- **Normal:** Under this mode, the oscilloscope samples the signal at equal intervals to reconstruct the waveform. This represents the analog signal correctly in most cases. However, this method cannot capture the rapid changes of analog signals between two sampling intervals, resulting in confusion and possible loss of narrow pulses in the signal. In order to obtain correct data under the above circumstances, peak detection acquisition mode should be applied.
- **Average:** Under this mode, oscilloscope takes a number of waveform and then takes the average, and displays the average waveform, which can be used to reduce random noise.
- **Peak detection:** Under this mode, the oscilloscope collects the maximum and minimum value of the input signal at each sampling interval and displays the waveform with the sampling data. In this way, the oscilloscope can acquire and display narrow pulses that might be lost. However, the noise effect will be more obvious.
- **High resolution:** This mode uses a hypersampling technique that evenly samples adjacent points of the waveform to reduce random noise on the input signal and produce smoother waveforms on the screen. This method is usually used when the sampling rate of the digital converter is higher than the storage rate of the acquisition memory.

11.2 Average times

Average times:

When the average acquisition mode is selected, the average number can be set. The higher the average number is, the lower the noise is. The range is 2-256.

11.3 Display mode

The display mode can be YT, XY, and scroll.

YT mode:

The most commonly used display mode, Y-axis represents the voltage, X-axis represents the time. When the horizontal time base is greater than 100ms, the oscilloscope automatically enters the scanning mode.

When the large time base is large (such as 200ms and above), sometimes the waveform will not be displayed for a long time. This is because under YT mode, waveform must be triggered before display. This time has a great relationship with the time base, which can be roughly calculated as: the number of grids on the left of the trigger position * the time base gear. If you want to reduce the wait time, you can move the trigger position to the left. We do not consider moving the trigger position off the waveform screen.

XY mode:

The oscilloscope converts two data channels from a voltage-time display to a voltage-voltage display.

XY mode is used to analyze the phase difference, such as those described by lissajous figures.

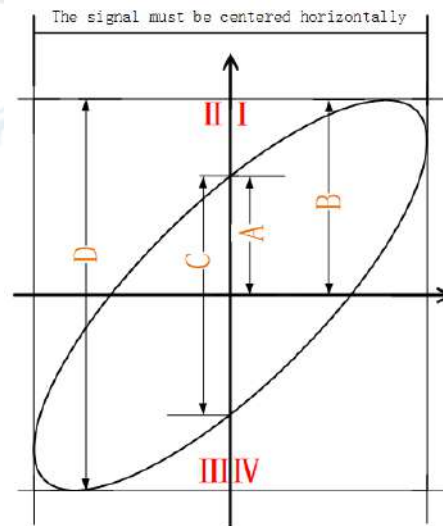

Figure 11.1 Phase difference schematic diagram

According to $\sin \theta = A/B$ or C/D , where θ is the angle difference between channels, A, B, C and D are defined in the figure above. Thus the angle difference can be obtained, namely: $\theta = \pm \arcsin(A/B)$ or $\pm \arcsin(C/D)$.

If the principal axis of the ellipse is in quadrants I and III, the obtained phase difference angle should be in quadrants I and IV, that is, in $(0$ to $\pi/2)$ or $(3\pi/2$ to $2\pi)$. If the

principal axis of the ellipse is in quadrants II and IV, the phase difference angle obtained should be in quadrants II and III, that is, within $(\pi/2 \text{ to } \pi)$ or $(\pi \text{ to } 3\pi/2)$.

This mode divides the voltage of channel 1 relative to the voltage of channel 2, where channel 1 is the horizontal axis and channel 2 is the vertical axis. The oscilloscope uses an untriggered "sampling mode" and displays the data as points. The sampling rate is fixed at 1MS/s.

Oscilloscope can acquire the waveform in normal YT mode at any sampling rate. You can view the same waveform under XY mode. To do this, stop the acquisition and change the display mode to XY.

Scroll mode:

Waveform refresh display from right to left. The range of the horizontal time base is 100ms to 100s.



Figure 11.2 Scroll mode

Under scroll mode, tap the H/R key to stop the display of waveform. Tap the H/R key again to clear the waveform display and restart the collection.

The scroll mode is generally used to observe waveforms with frequencies below 5Hz. The scroll mode is enabled by default. When the time base is greater than 100ms, the rolling mode is automatically enabled. If you need to view signals to be triggered in a large time base, disable the scroll mode.

11.4 Storage depth

Memory depth refers to the number of waveform points an oscilloscope can store in a trigger acquisition. It reflects the storage capacity of the acquisition memory.

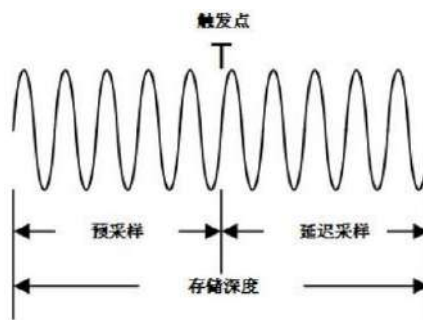

Figure 11.3 Schematic diagram of storage depth

The relationship between storage depth, sampling rate and horizontal base gear is as follows:

$$MDepth = SRate * TSCale * HDivs$$

- MDepth: storage depth, in unit pts.
- SRate: sampling rate, in unit Sa/s.
- TSCale: horizontal time base gear, in unit s/div.
- HDivs: the number of grids in horizontal direction, in unit div.

Therefore, at the same horizontal time base gear, high storage depth can ensure high sampling rate.

Click **Auxiliary > Acquisition** to open the acquisition menu.



Select a storage depth. The default storage depth is 4K. Click the storage depth or down arrow to select another storage depth.

Optional storage depth: 4K, 20K, 200K, 2M, 4M, or 8M.

In single-channel mode, the maximum storage depth is 8M.

In double-channel mode, the maximum storage depth is 4M.

In triple or quadruple-channel mode, the maximum storage depth is 2M.



Tip:

Under sAutomatic mode, the oscilloscope automatically selects the storage depth based on the current sampling rate.

11.5 Interpolation methods

Under real - time sampling, oscilloscope obtains discrete samples of the displayed waveform. In general, waveforms displayed by dots are difficult to observe. In order to increase the visibility of the signal, the digital oscilloscope usually adopts interpolation display mode. Interpolation is a method of connecting sample points and calculating the whole wave form from some points. For real-time sampling using interpolation, even if the oscilloscope only collects a few sampling points, interpolation can be used to fill the gaps between points and reconstruct accurate waveforms. Interpolation methods include sine wave interpolation, step interpolation and linear interpolation.

Sine wave interpolation

The result is calculated in the actual sample interval by mathematical processing. This method bends the signal waveform to produce ordinary shapes that are more realistic than pure square waves and pulses. Sinusoidal interpolation is recommended when the sampling rate is 3 to 5 times the system bandwidth.

Step interpolation

Insert the value of the previous sample point between adjacent sample points. This algorithm is the same as the normal sampling of the oscilloscope ADC. The data is interpolated by sample-and-hold method to improve the sampling rate of the signal.

Linear interpolation

Connect a straight line directly between adjacent sample points. This method is limited to reconstructing signals with straight edges, such as square waves. Sinusoidal interpolation uses curves to connect sampling points and has more universality.

12 Display

The acquisition of a waveform display depends on a number of settings. Once the waveform is obtained, it can be measured. The display of these waveforms in various forms also provides important information about the waveforms.

Click **Utility > Display** in the lower left corner of the screen to open the display menu.

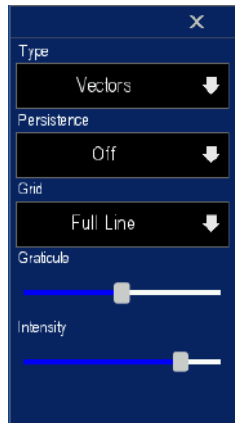

12.1 Type

The display type can be vector or point to determine whether the waveform is displayed as a vector or a dot. Vector display will fill the space between adjacent sample points while point display only shows sample points.

Under vector display, the sample points are connected by lines. This mode provides the most realistic waveform in most cases and makes it easy to view the steep edges of the waveform (e.g. square wave).

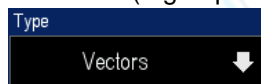

12.2 Persistence

Select afterglow time (off, infinite, 1 second, 5 seconds, 10 seconds, 30 seconds).

Afterglow function can be retained until the specified time runs out.

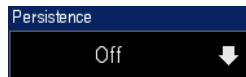

- Afterglow OFF: Observe waveform changes with high refresh rate.
- Specific value: Observe burrs with slow change or low probability. The afterglow time can be set to 1s, 5s, 10s, or 30s.
- Infinite: When the oscilloscope displays the newly acquired waveform, it does not clear the previously acquired waveform. The acquired waveforms are displayed in low brightness, and the newly acquired waveforms are displayed in normal brightness and color. Use infinite afterglow to measure noise and jitter, and capture accidental events.

12.3 **Grid**

Grid types include solid line, none, and dotted line.

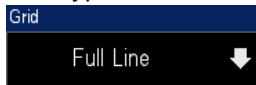

Solid line: The background grid is solid line.

None: No background grid.

Dots and lines: The background grid is a dot.

12.4 **Grid brightness**

Adjust grid brightness by sliding the slider left and right with one finger.



12.5 **Waveform brightness**

Adjust waveform brightness by sliding the slider left and right with one finger.



13 Save

Click **Utility** > **Save** in the lower left corner of the screen to open the Save menu. Oscilloscope pictures, binary (.lwf), reference (.ref), settings (.pho) and CSV can be stored in internal memory of the machine or external storage device. The saved content supports call-out. Select save reference data source (CH1-CH4), select the type you want to save, and click **Save** at the bottom of the screen to save.



1. Picture

Save the display interface to file browse or external memory in .bmp format. Image files support call-out.

2. Binary (waveform)

Save the oscilloscope waveform to the internal or external memory of the machine in the format lwf. Binary files support call-out.

3. Settings

Save the oscilloscope settings to the internal or external memory of the machine in the format .pho. Settings files support call-out.

4. Reference

Save the oscilloscope reference waveform to the internal or external memory of the machine in the format .ref. Reference files support call-out.

5. CSV

Save oscilloscope waveform data to internal or external memory of the machine in the format .csv. The storage file contains the waveform data of the display channel and the main settings of the oscilloscope. CSV files cannot be exported.

The pictures and other contents saved in the machine can be found and opened in the file browse under the main interface. Images can also be found and opened in the gallery under the main interface. See the [File browse](#) and [Gallery](#) sections for details.

14 Calibration

The self-calibration program optimizes the oscilloscope signal path with maximum measurement accuracy. You can run this program at any time, especially when the temperature changes by more than 5 ° C or more.

For more accurate calibration, please turn on the oscilloscope power supply, preheat 30 minutes before self-calibration. Follow the on-screen prompts. To compensate for the signal path, disconnect any probes or cables connected to the input connector.

Under the oscilloscope menu, click **Auxiliary** and select **Calibration**. Follow the instructions on the display screen.

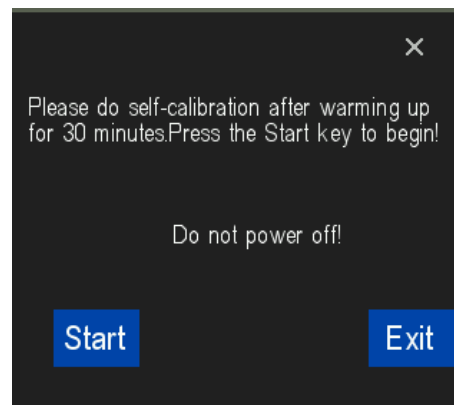

Figure 14.1 Calibration menu

Start: Click **Start** to start the calibration.

Exit: If oscilloscope is in the calibration process, click **Exit** to exit the calibration.

X: Close the calibration interface.

If the machine completes the calibration normally and successfully, it will automatically exit the calibration interface.

15 Shortcuts

Auto setting: Auto setup of oscilloscope controls to generate useful display of input signals. See the following table for relevant information.

Click **Auto** at the bottom of the screen, and the oscilloscope will perform Auto setting automatically.

Default setting: Automatically call out the default settings. Click **Utility > Default**.

15.1 Auto setting

Auto setting is one of the advantages of digital oscilloscopes. When you click Auto setting, the oscilloscope will recognize the waveform type (sine or square) and adjust the control mode to accurately display the waveform of the input signal.

| Function | Settings |
|--------------------------------|---|
| Acquisition mode | Sampling or peak detection |
| Cursor | OFF |
| Display mode | YT |
| Display type | FFT spectrum is set to vector. Otherwise, no change. |
| Horizontal position | Has been adjusted |
| SEC/DIV | Has been adjusted |
| Trigger coupling | Set to DC, noise suppression, or high frequency suppression |
| Trigger hold-off | 20ns |
| Trigger level | 50% |
| Trigger mode | Automatic |
| Trigger source | Has been adjusted. Automatic setting cannot be used for external trigger signals. |
| Trigger slope | Has been adjusted |
| Trigger type | Edge |
| Video | |
| synchronizatio n trigger | Has been adjusted |
| Video trigger standard | Has been adjusted |
| Vertical bandwidth | All |
| Vertical coupling | DC (if GND was previously selected). For video signals, set it to AC. Otherwise, no change. |

| Function | Settings |
|-----------|-------------------|
| VOLTS/DIV | Has been adjusted |

Table 15.1 Automatic setting

Automatic setting function checks all channel signals and displays corresponding waveforms. Automatic setting determines the trigger source based on the following criteria.

- If multiple channels input signals, choose the low frequency signal channel as the trigger source.
- If no signal is found, choose the lowest-numbered channel displayed as the trigger source.
- If no signal is found and no channel is displayed, the oscilloscope will display the CH1 channel and take it as the trigger source.

When the automatic setting function is used and the oscilloscope determines that the signal resembles a sine wave, the oscilloscope will display the following options:

| Waveform options | Detailed instructions |
|------------------|---|
| Multiple cycles | Display multiple cycles with appropriate vertical and horizontal scales. |
| Single cycle | Set the horizontal scale to display a period of the waveform. |
| Automatic range | Automatic setting. |
| Data source | Select the data source: Display the current channel only or display all channels. |
| Cancel | Restore the oscilloscope to previous settings. |

Table 15.2 Automatic setting of sine waves¹⁵

15.2 Default setting

Click the **Utility > Default**.

Click **Default** and the oscilloscope will display waveforms of the 4 channels. The following table shows settings for options, buttons, and controls under default setting.

| Menu or system | Options, labels or knobs | Default settings |
|----------------|--------------------------|------------------|
| Acquisition | Mode | Normal |
| Running state | Run/stop | Run |
| Cursor | State | OFF |
| | Type | Vector |
| Display | Afterglow | OFF |
| | Mode | YT |
| Horizontal | Window mode | Single window |

| Menu or system | Options, labels or knobs | Default settings |
|-------------------------------|--------------------------|----------------------------|
| | Trigger knob | level |
| | Position | Channel 1 |
| | Seconds/grid | 200 μ s |
| Math | State | OFF |
| measurement | State | OFF |
| | Type | Edge |
| | Data source | CH1 |
| Trigger (edge) | Slope | Rising edge |
| | Method | Automatic |
| | Level | 0.00 v |
| | | |
| Vertical system, all channels | Bandwidth limit | Unlimited |
| | Voltage/grid | Rough adjustment |
| | Probe attenuation | 1X |
| | Phase inversion | OFF |
| | Position | Different for each channel |
| | Voltage/grid | 1V |

Table 15.3 Default setting15

The following settings do not change when the default setting is selected.

- Language
- Save settings
- Save reference waveform
- Display contrast
- Calibration data

16 Multimeter

This oscilloscope provides simple multimeter function.

You can access the multimeter by the following methods:

- Click the [Multimeter] icon on the main interface.
- Tap the virtual key [DMM] on the left of the screen.

The multimeter interface is shown in the following figure.

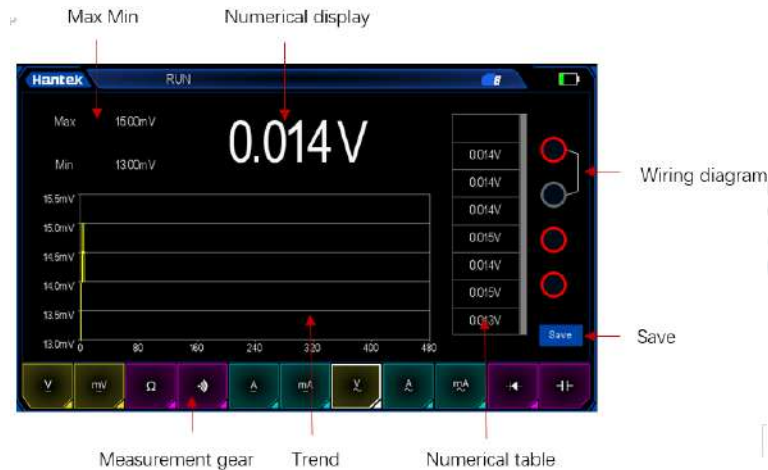

Figure 16.1 Multimeter

Value range:

The range of current measurement gear, maximum and minimum.

Numerical display:

Real-time display of the current measured value.

Measurement gear:

DC voltage V, DC voltage mV, resistance, on/off, DC current A, DC current mA, AC voltage V, AC current A, AC current mA, diode, capacitor.

Trend diagram:

Updated trend charts based on measured values.

Numerical tables:

Record the measured values in the table. The slider bar on the right side of the table allows you to view the previously saved data.

Save:

Click Save to save the measured value to a USB disk.

Connection chart:

The connection method suggested when measuring different gears.

16.1 Measurement

1. Dc and AC voltage measurement

- Click [**DMM**] on the main interface to enter the multimeter interface.
- Select DC volt (V-), DC millivolt (mV-), AC volt (V ~).
- Insert the black probe into the COM banana jack input terminal, the red probe into the V/ Ω /C banana jack input terminal.
- Connect the red and black probes to the measured point. The voltage value of the measured point will be displayed.

2. DC and AC current measurement

- Click [**DMM**] on the main interface to enter the multimeter interface.
- To measure the DC current greater than 200mA, select DC ampere (A-) and AC ampere (A ~), insert the black probe into the COM banana jack input terminal, the red probe into the banana jack input terminal.
- To measure the DC current less than 200mA, select DC milliampere (mA-) and AC milliampere (mA ~), insert the black probe into the COM banana jack input terminal, and the red probe into the mA banana jack input terminal.
- Connect the red and black probes to the measured point. The voltage value of the measured point will be displayed.

3. Resistance measurement

- Click [**DMM**] on the main interface to enter the multimeter interface.
- Select resistance (Ω);
- Insert the black probe into the COM banana jack input terminal, the red probe into the V/ Ω /C banana jack input terminal.
- Connect the red and black probes to the measured point. The voltage value of the measured point will be displayed.

4. Capacitance measurement

- Click [**DMM**] on the main interface to enter the multimeter interface.
- Select capacitance (F);
- Insert the black probe into the COM banana jack input terminal, the red probe into the V/ Ω /C banana jack input terminal.
- Connect the red and black probes to the measured point. The voltage value of the measured point will be displayed.

5. Diode measurement

- Click [**DMM**] on the main interface to enter the multimeter interface.
- Selective diode (D).

- Insert the black probe into the COM banana jack input terminal, the red probe into the V/ Ω /C banana jack input terminal.
- Connect the red and black probes to the diode under test and the screen will display the reading of the positive conduction voltage for the diode. The unit is in V.

6. On off measurement

- Click [**DMM**] on the main interface to enter the multimeter interface.
- Select sound (🔔), the buzzer rings.
- Insert the black probe into the COM banana jack input terminal, the red probe into the V/ Ω /C banana jack input terminal.
- Connect the red and black probes to the measured point. The the voltage value of the measured point will be displayed.



Note:

Please correctly select the measurement gear before measuring.

17 Signal source

Click [AFG] to enter the signal source interface.

Users can edit any waveform or select sine wave, square wave, triangle wave, noise, DC and arbitrary waveforms.

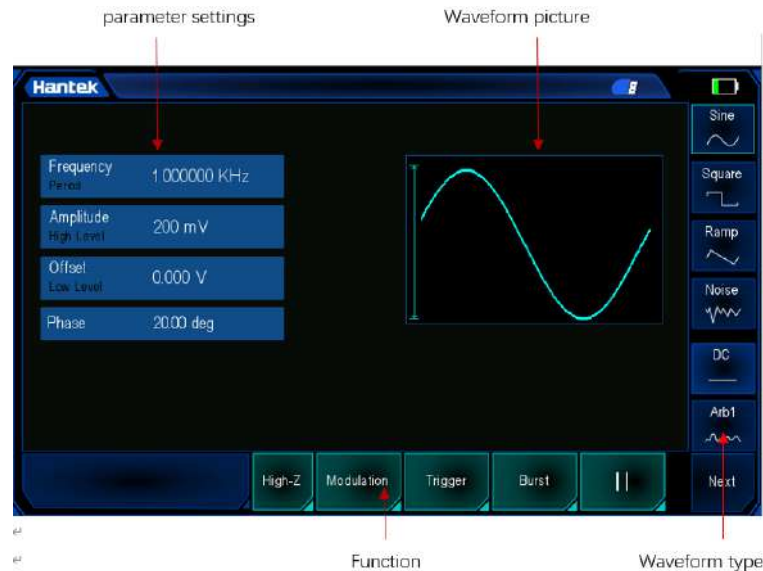

Figure 17.1 Signal source

17.1 Set the output waveform type and parameters

1. Enter the Signal source interface.
2. Select the desired **Waveform** on the right and click Confirm. Click Next to set extra arbitrary waves.
3. Click **Frequency** to set the frequency. Click it again to set the **Period**. Click the number to call out the numeric keypad to set the value.
4. Click **Amplitude** to set the amplitude. Click it again to set the high level (the offset is automatically switched to the low level). Click the number to call out the numeric keypad to set the value.
5. Click **Offset** to set the offset. Click it again to set the low level (the amplitude is automatically switched to the high level). Click the number to call out the numeric keypad to set the value.
6. Click **Phase** to set the phase. Click the number to call out the numeric keypad to set the value.
7. Click **Duty cycle** to set the duty cycle of the square wave.
8. Click **Symmetry** to set the symmetry of the triangle wave.
9. Click **High-Z** repeatedly to set the output load impedance of the waveform generator. The default value is 50Ω.

17.2 Set waveform modulation

Click **Modulation** to enter the modulation menu.

Modulation

There are two types of modulation, amplitude modulation (AM) and frequency modulation (FM).

AM: Modify the amplitude of the original carrier signal according to the amplitude of the modulated signal.

FM: Modify the frequency of the original carrier signal according to the frequency of the modulated signal.

Shape:

Select the waveform of modulated wave, including sine wave, square wave and triangle wave.

Frequency:

Set the frequency of the modulated wave, ranging from 1Hz to 50KHz.

Depth:

Sets the amplitude modulation depth. The settable range is 0-120%.

Offset:

Set the modulation offset of frequency modulation, that is, the offset between the modulated waveform frequency and the original carrier frequency. The range is 0.1Hz~1KHz carrier frequency. (Carrier wave is the modulated wave, and the carrier frequency is the frequency of the selected waveform output by the signal generator except noise and DC.) The sum of the modulation offset and carrier frequency must be less than or equal to the sum of the upper limit of carrier frequency and 1KHz.

Set frequency, depth and offset:

Click on the numeric area to call out the numeric keypad to set the value.

17.3 Set burst

Click **Burst** to access the burst menu.

Click the the digital area of Count to call out the numeric keyboard to set the number of pulses. The settable range is 1~2000000000.

When the burst menu is opened, the burst is on. When the burst menu is closed, the burst is off.

Click **Burst** to open the burst menu. Set **count** and click **Trigger** to get the corresponding waveform state.

Note: You need to connect the signal source to another oscilloscope.

17.4 Edit arbitrary waveform

Double-click "**WaveEditor_Setup_Tablet1000.exe**" in the waveform editor folder in the CD to go to arbitrary waveform editing window.

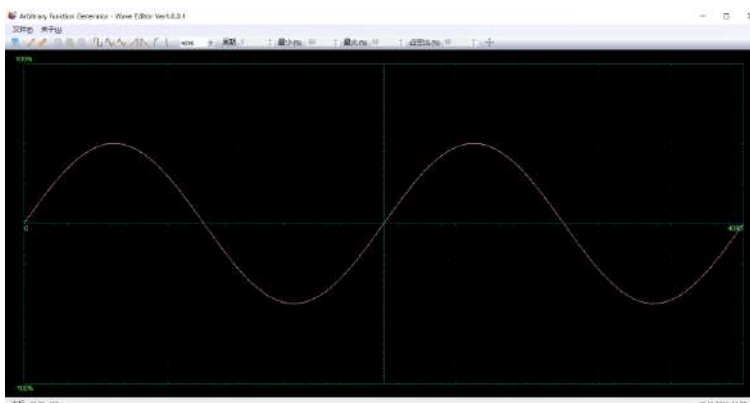

Figure 17.2 Arbitrary wave editor

Menu:

Import from a CSV file: Import the CSV file to the arbitrary waveform editor interface.

Export to a CSV file: Save waveform data to a CSV file.

Import from an ARB File: Import ARB file into the arbitrary waveform editor interface.

Export to an ARB file: Save waveform data to an ARB file.

Note: The device can call up ARB files saved in the USB flash drive, but CSV files cannot be called up.

Toolbar buttons



Download waveform data to the device.



Smooth drawing mode. Use the left mouse button to draw waveforms of any shape.



Linear drawing mode. Click on the waveform to draw a straight line from the previous point.



Zoom tools. Zoom in or out on the timeline. Click the + or - button, and then click on the waveform area. Click the 100% button to restore the timeline to its original scale.



Standard waveform shape. Use the numeric control at the bottom of the toolbar to draw the standard waveform according to the specified settings.

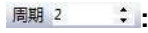

Period number. The number of periods of drawn waveform. This control should be used in conjunction with the standard waveform shape button. Select a standard waveform and set the period number to draw waveform with desired number of periods.



Minimum. This control sets the minimum signal level when the standard waveform shape is selected.



Maximum. This control sets the maximum signal level when the standard waveform shape is selected.



Duty ratio. This control sets the duty cycle when selecting a square, triangle, or diagonal using the standard waveform shape button. Duty cycle is defined as the time the signal is above zero volt divided by the total period time. Thus, a symmetric square or triangular wave has a duty cycle of 50%. Reducing duty cycle shortens the positive part of the cycle and lengthens the negative part.

When using waveform editor software, the frequency, amplitude and offset of arbitrary wave cannot be adjusted, but after the waveform data is downloaded to the device, they can be adjusted by setting the device.

Do not use the waveform editor and oscilloscope software at the same time, otherwise it will cause errors.

17.5 Output arbitrary waveform

Method 1

1. Double-click the **WaveEditor_Setup_Tablet1000** icon to open the software.
2. Connect the machine and computer with a USB cable.
3. Select a waveform file or draw an arbitrary waveform and click on the icon  in the toolbar. Then select a download location of the waveform data and download the waveform to Arb1~Arb4 in the signal source menu.



4. Enter the **Signal source** menu. Select Arb1~Arb4, call up ARB files to output waveform. The AFG port will output waveform.

Method 2

1. Double-click the **WaveEditor_Setup_Tablet1000** icon to open the software.
2. Plug in USB storage.
3. Select a waveform file or draw an arbitrary waveform. Click Menu and choose Export to ARB file, save the file to your computer or elsewhere.
4. Copy the ARB files saved to your computer to the USB storage device. The USB storage device can save only one ARB file at a time, and the name of the ARB file can only be **dds.arb**.
5. Plug the storage device with ARB files into the machine. Enter the signal source interface and select one among Arb1 ~ Arb4. Hold down until the message “Call out successfully” is displayed. The AFG port will output the waveform.

18 File browse

In the main interface, click the [**File Browse**] icon to enter the file browse menu.

File browse includes: image, reference, CSV, binary, and settings.



Figure 18.1 File browse

Under the oscilloscope interface, select the save type, and file will be saved to store to the File browse or a U disk in the selected type. If no USB flash drive is connected, the file is saved in File browse by default. If a USB flash drive is connected, the file is automatically saved in the USB flash drive.

The files are saved in File browse. Click File browse on the main interface and select the file to call out.

- **Picture:** Select the picture to open. The interface of the opened picture is the same as the interface opened in the Gallery. you can choose the last or next one or delete. Click Return to return to the gallery interface.
- **Reference:** The reference waveform file can directly open the reference channel in the oscilloscope interface, and then call the reference waveform.
- **CSV:** CSV files cannot be called out directly on the machine. If you save it on a USB flash drive, you can open it on your computer.
- **Binary:** Select the binary file to be called out in File browse. The pop-up box will prompt “Successfully called out”. Return to the oscilloscope interface, you can see the binary file called out.
- **Settings:** Select the setting file to be called out in File browse. The pop-up box will prompt “Successfully called out”. Return to the oscilloscope interface, you can see the settings file called out.

There are delete and rename options on the right side of the File browse interface.

Delete

- Select the file to delete.
- Click Delete.
- Pop-up: Are you sure you want to delete the file?
- Select Confirm or Cancel.

If no file is selected, the first file will be deleted.

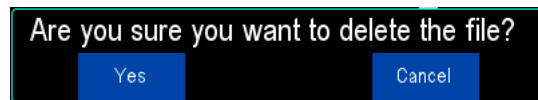

Rename

The renaming rule is a combination of letters and digits.

- Select the file to rename.
- Click Rename.
- The keyboard will pop up.
- Set the name.
- Click Enter to complete the renaming.

For specific operations, please refer to the section of [Setting parameters](#).

19 Settings

| Options | Instructions |
|--------------------|---|
| Language | Select the language. English or Chinese. |
| System information | Display the machine model, serial number, software version, hardware version, and firmware version. |
| Voice | Adjust touch screen sound and set boot music. |
| Brightness | Adjust screen brightness. |
| Upgrade | Insert a USB flash drive with only a upgrade file. Click the Upgrade soft key. |
| Automatic lock | Automatic lock time and automatic shutdown time. |
| USB sharing | Connect the machine and computer with USB. The computer can read the files saved in the machine. |

Table 19.1 Settings

Language

Two languages: English or Chinese.



System information

Display the machine model, serial number, software version, hardware version, and firmware version.



Voice

Use the slider to adjust the volume. Change the boot music as prompted.

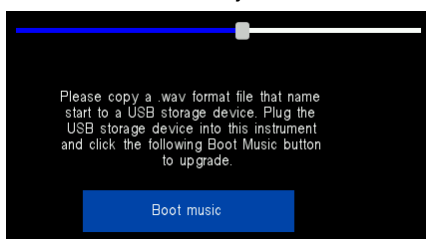

Brightness

Use the slider to adjust the brightness.



Upgrade

The firmware can be upgraded using USB storage devices. The whole process takes about two minutes.

Perform the following steps to upgrade the firmware:

1. Insert the USB storage device with only an upgrade package into the USB HOST interface on the side panel of the oscilloscope.
2. Click [**Setting**] in the main interface to enter the setting interface.
3. Click **Upgrade** on the Setting interface and click the upgrade tab in the middle of the screen to upgrade the firmware.
4. After the upgrade, the oscilloscope will restart and the firmware version will be updated. The self-calibration should be performed after upgrade.

After the upgrade is successful, the saved files and pictures will be cleared.



Note: The USB storage device can contain only the upgrade file, and the name of the upgrade file cannot be modified randomly as shown in the following figure.

Otherwise, the machine cannot be upgraded normally.



Automatic lock

Set the automatic lock time (screen-off time) and automatic shutdown time.

There are five automatic lock modes: 15S, 30S, 45S, 60S, and unlimited.

There are five automatic shutdown modes 15 minutes, 30 minutes, 45 minutes, 60 minutes and unlimited. The automatic shutdown time is the time when the machine will shut down after the screen is turned off.

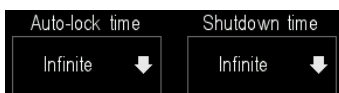

USB sharing

Follow these steps to perform USB sharing:

1. Connect the machine to the computer by USB.
2. Click USB sharing and click the USB sharing tab in the middle of the screen.

USB-Share

3. The computer pops up a removable disk and opens it to read files stored in the machine (mini_pic、image、ref、csv、setup、wave、mask).

- mini_pic
- image
- ref
- csv
- setup
- wave
- mask

4. Click ON/OFF to exit USB sharing.

20 Gallery

On the main interface, click **[Gallery]** to enter the gallery menu.



Figure 20.1 Gallery

Save pictures:

- Click **[PRINT]** to take a screenshot directly.
- Enter the Oscilloscope interface, open **Auxiliary** > **Save**, select the save type as picture, and click **Save**.

Click the picture in the gallery, you can select the Last, Return to gallery, Delete Next tabs for operation.



A maximum of 16 images can be saved in the gallery. If there are more than 16 images, they will be overwritten from the first image. If you delete an image in the middle, the next saved image will be saved in the same place as the previous deleted image, and the images saved later will continue in the previous order.

21 Remote control

This chapter mainly includes the application of upper computer, in order to understand the remote control function of Tablet1000 oscilloscope.

Install the IO driver:

Click on the following website to download the latest IO software:

[- 11143.0.00 & id = 2175637](#)

Double-click the application to start the installation. The installation process may take several minutes.

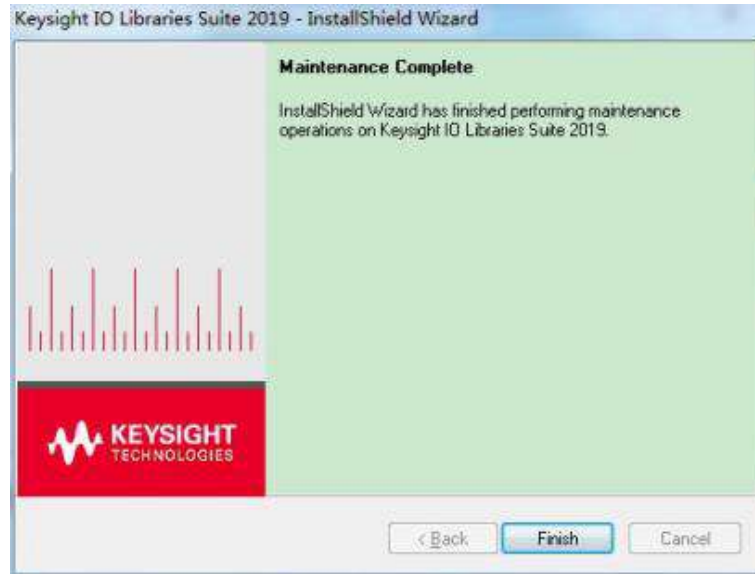

After the installation, you can view the I/O software running in the lower right corner of the screen.



Connect the Type-A end of the USB cable to the computer, and connect the Type-B end to the USB interface at the back of the oscilloscope. A new device will display in Computer Device Manager.

- ▼ USB Test and Measurement Devices
 - USB Test and Measurement Device (IVI)

Double-click the IO software, and you can view the connected device information displayed under My Instrument-USB.

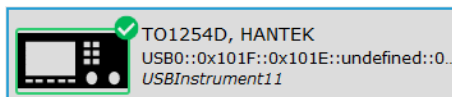

Click "Interactive IO" and send an instruction, then the computer is in communication with the oscilloscope.

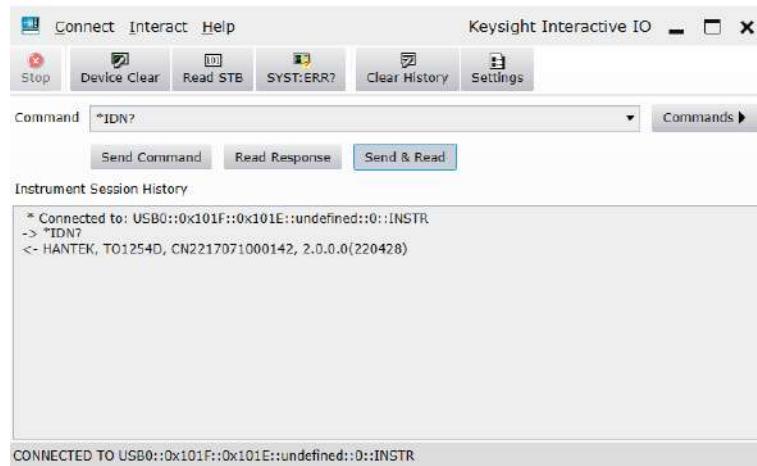

Double-click to open the upper computer software. If you see the connection information in the lower left corner of the interface, it indicates the upper computer has been connected.



22 Fault handling

If you press the power button, there is still no display.

- Check whether the battery is charged.
- Check whether the power button is pressed firmly.
- After the above examination, restart the instrument.
- If you still cannot use this product properly, please contact Hantek.

After the oscilloscope is turned on, no waveform is displayed on the input signal screen.

- Check whether the probe is properly connected to the BNC connector of the signal input channel.
- Check whether the channel switch is enabled (CH1 to CH4).
- Check that the input signal is properly connected to the probe.
- Verify that the measured circuit has signal output.
- If it is a DC signal and the amplitude is high, adjust the amplitude gear to a higher value.
- Press the automatic measurement button to automatically detect the signal first.
- If still no waveform is displayed, contact Hantek for technical support.

Serious distortion of the input signal waveform.

- Check whether the oscilloscope probe is properly connected with the BNC connector.
- Check whether the probe is properly connected to the object under test.
- Check whether the probe is well calibrated, if not, please calibrate it according to the relevant chapter in the manual.

The waveform is constantly scrolling on the screen and cannot be triggered.

- Check whether the trigger source is consistent with the signal input channel.
- Check whether the trigger level is properly adjusted.
- Check whether the trigger mode is appropriate., The default trigger mode is edge trigger, and the trigger should be selected correctly for different input signals.

23 Appendix

23.1 Appendix A: Accessories

| Order information | Order number |
|--|--------------|
| Host model | |
| 250MSa/S, 110MHz, 2-channel oscilloscope | TO1112 |
| 250MSa/S, 110MHz, 2-channel oscilloscope + multimeter | TO1112C |
| 250MSa/S, 110MHz, 2-channel oscilloscope + multimeter + signal source | TO1112D |
| 1GSa/S, 150MHz, 2-channel oscilloscope | TO1152 |
| 1G Sa/S, 200MHz, 2-channel oscilloscope | TO1202 |
| 1G Sa/S, 250MHz, 2-channel oscilloscope | TO1252 |
| 1G Sa/S, 150MHz, 2-channel oscilloscope + multimeter | TO1152C |
| 1G Sa/S, 200MHz, 2-channel oscilloscope + multimeter | TO1202C |
| 1G Sa/S, 250MHz, 2-channel oscilloscope + multimeter | TO1252C |
| 1G Sa/S, 150MHz, 2-channel oscilloscope + multimeter + signal source | TO1152D |
| 1G Sa/S, 200MHz, 2-channel oscilloscope + | TO1202D |

| Order information | Order number |
|---|--------------|
| multimeter + signal source | |
| 1G Sa/S, 250MHz, 2-channel oscilloscope + | TO1252D |
| multimeter + signal source | |
| 1G Sa/S, 150MHz, 4-channel oscilloscope | TO1154 |
| 1G Sa/S, 200MHz, 4-channel oscilloscope | TO1204 |
| 1G Sa/S, 250MHz, 4-channel oscilloscope | TO1254 |
| 1G Sa/S, 150MHz, 4-channel oscilloscope + | TO1154C |
| multimeter | |
| 1G Sa/S, 200MHz, 4-channel oscilloscope + | TO1204C |
| multimeter | |
| 1G Sa/S, 250MHz, 4-channel oscilloscope + | TO1254C |
| multimeter | |
| 1G Sa/S, 150MHz, 4-channel oscilloscope + | TO1154D |
| multimeter + signal source | |
| 1G Sa/S, 200MHz, 4-channel oscilloscope + | TO1204D |
| multimeter + signal source | |
| 1G Sa/S, 250MHz, 4-channel oscilloscope + | TO1254D |
| multimeter + signal source | |
| 1G Sa/S, 150MHz, 4-channel oscilloscope + | TO1154AUTO |
| multimeter + signal source | |

| Order information | Order number |
|--|--|
| 1G Sa/S, 200MHz, 4-channel oscilloscope + multimeter + signal source | TO1204AUTO |
| 1G Sa/S, 250MHz, 4-channel oscilloscope + multimeter + signal source | TO1254AUTO |
| Standard accessories | |
| 9V2A/5V3A/12V1.5A adapter | -- |
| USB cable | -- |
| Multimeter Pen *1 (only for TO1000C/D series) | -- |
| | PP150B (110 MHz) |
| Oscilloscope probe (one for two-channel series, two for 4-channel series) | PP150B (150 MHz) PP200 (200 MHz) PP250 (250 MHz) |
| Crocodile clip (one for two-channel series, two for four-channel series) | HT324 |

23.2 Appendix B: Warranty summary

Qingdao Hantek Electronics Co., LTD. (hereinafter referred to as Hantek) undertakes that the host and accessories of its production shall be free from any material and process defects during the warranty period.

During the warranty period, if the product is proved to be defective, Hantek will repair or replace the product free of charge. Please refer to the description on Hantek official website for detailed warranty regulations. For repair service or full warranty instructions, please contact Hantek repair center or local offices.

Hantek disclaims warranties, express or implied, other than those provided in this summary or any other applicable warranty card, including, but not limited to, any implied warranties of merchantability and fitness for special purpose. In no event shall Hantek be

liable for indirect, special or consequential damages.





Addr: #35 Building, No. 780 Baoyuan Road, High-tech Zone, Qingdao, Shandong, China 266114

Switchboard: 400-036-7077

Email: service@hantek.com

Tel: (0086)532-55678770 & 55678772 & 55678773

Zip code: 266114

Website: www.hantek.com

Qingdao Hantek Electronics Co., LTD